

For online reference and to download the manuals for your machines , go to:-

<https://www.e-technical-information.com>

or, scan the QR Code below



OPERATOR'S MANUAL

HA16RTJ - HA16RTJ O - HA16RTJ PRO - HA46RTJ O -
HA46RTJ PRO

Color screen display

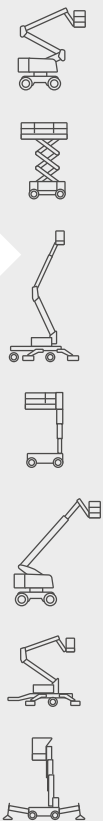

A-Foreword

1	Foreword.....	3
2	Responsibilities.....	4
2.1	Owner's responsibility.....	4
2.2	Employer's responsibility.....	4
2.3	Trainer's responsibility.....	4
2.4	Operator's responsibility.....	4
3	Safety.....	5
3.1	Safety instructions.....	5
4	Safety inquiries.....	12
5	Incident notification.....	13
6	Compliance.....	14
6.1	Product modification.....	14
6.2	Product specifications.....	14
6.3	Change of Ownership Notification.....	14
6.4	Declaration of conformity.....	16

B-Familiarization

1	General safety.....	3
1.1	Intended use.....	3
1.2	Decal content.....	3
1.3	Level of severity.....	4
1.4	Symbols legend and definitions.....	5
1.5	Symbols and colors.....	7
2	Models description.....	8
3	Primary machine components.....	9
3.1	Description.....	9
3.2	Ground control box - Service / Emergency station.....	11
3.3	Platform control box - Main station.....	32
4	Performance Specifications.....	37
4.1	Technical characteristics.....	37
4.2	Engine specifications.....	43
4.3	Working area / Range of motion.....	45
5	Decals and markings locations.....	46

C-Pre-operation inspection

1	Recommendations.....	3
2	Working area assessment.....	4
3	Inspection and Functional test.....	5
3.1	Daily inspection.....	5
4	Safety functional checks.....	10
4.1	Emergency Stop button check.....	10
4.2	Activation of controls.....	11
4.3	Fault detector.....	11
4.4	Automatic engine cut-out.....	12

Contents

4.5	Overload sensing system.....	12
4.6	Oscillating axles (If equipped)	12
4.7	Slope warning device.....	12
4.8	Travel speed limitation.....	14
4.9	On-board electronics.....	14
4.10	Braking test.....	15
4.11	Overload test.....	15

D-Operation instructions

1	Operation.....	3
1.1	Introduction.....	3
1.2	Major description.....	3
1.3	Operation from the ground control box (Service / Emergency station)	3
1.4	Operation from the platform control box (Main station)	4
2	Ground control box - Service / Emergency station.....	6
2.1	To start and stop the machine-Diesel engine.....	6
2.2	To start and stop the machine - Petrol / gas (Propane) Engine.....	6
2.3	Movement control.....	6
2.4	Additional controls.....	8
3	Platform control box - Main station.....	9
3.1	To start and stop the machine.....	9
3.2	To start and stop the machine - Petrol / gas (Propane) Engine.....	9
3.3	Drive and steer control.....	10
3.4	Movement control.....	10
3.5	Additional controls.....	12
4	Rescue and emergency procedures.....	13
4.1	In case of power loss.....	13
4.2	To rescue operator in platform.....	14
4.3	Operation of overriding system from ground control box.....	14
4.4	No power available.....	14
5	Transportation.....	15
5.1	Transport configuration.....	15
5.2	Machine stowage for transport - HA16RTJ - HA16RTJO - HA16RTJ PRO - HA46RTJO - HA46RTJ PRO.....	16
5.3	Unloading.....	17
5.4	Towing.....	17
5.5	Storage.....	18
5.6	Lifting operation.....	19
6	Cold Weather Recommendations.....	21
6.1	Engine oil.....	21
6.2	Hydraulic oil.....	22
6.3	Preheating operation.....	22

E-General Specifications

1	Machine dimensions.....	3
2	Major component masses.....	6
3	Acoustics and vibrations.....	7

Contents

4	Wheel/Tire assembly.....	8
4.1	Technical specifications.....	8
4.2	Inspection and maintenance.....	8
5	Options.....	11
5.1	Compatibility.....	11
5.2	Advanced Access Management - Access control and usage restriction.....	11
5.3	Platform.....	24
5.4	On-board generator.....	25
5.5	Glazier's kit.....	27
5.6	Plumber's kit.....	30
5.7	Activ' Shield Bar - Secondary crush risk reduction system (If fitted)	34
5.8	Sand tires.....	37

F-Maintenance

1	General.....	3
2	Maintenance Schedule.....	4
3	Inspection program.....	5
3.1	General program.....	5
3.2	Daily inspection.....	5
3.3	Periodic inspection.....	5
3.4	Reinforced inspection.....	6
3.5	Major inspection.....	6
4	Repairs and adjustments.....	7

G-Other information

1	Conditions of warranty.....	3
2	Subsidiary contact information.....	4
2.1	California warning.....	5

H-Records

1	Intervention register.....	3
----------	-----------------------------------	----------

A - Foreword

1	Foreword.....	3
2	Responsibilities.....	4
2.1	Owner's responsibility.....	4
2.2	Employer's responsibility.....	4
2.3	Trainer's responsibility.....	4
2.4	Operator's responsibility.....	4
3	Safety.....	5
3.1	Safety instructions.....	5
4	Safety inquiries.....	12
5	Incident notification.....	13
6	Compliance.....	14
6.1	Product modification.....	14
6.2	Product specifications.....	14
6.3	Change of Ownership Notification.....	14
6.4	Declaration of conformity.....	16

1 Foreword

You have just purchased a HAULOTTE® product and we would like to thank you for your business.

The aerial work platform is a device for lifting people designed and manufactured with the intent to enable users to access overhead elevated temporary workplaces with the necessary tools and equipment. All other uses or alterations/modifications to the aerial work platform must be approved by HAULOTTE®.

This manual shall be considered a permanent component of the machine and shall be kept with the aerial work platform in the designated Manual Holder, at all times.

Safe operation of this product can only be assured if you follow the operating instructions contained in this manual. To ensure the safe and appropriate use of this equipment, only trained personnel are authorised to use and carry out maintenance on the aerial work platform.

We would particularly like to draw your attention to 2 essential points:

- Comply with safety instructions.
- Use this equipment within the performance limits specified by this user manual.

With regard to the designation of our equipment, we stress that this is purely for commercial purposes and not to be confused with the technical specifications. Only the specifications in this manual should be used to study the suitability of the equipment for the intended use.

This operator's manual is specific to the HAULOTTE® products listed on the cover page of this manual.



Original language and version: Manuals in English and French are the original instructions. Manuals in other languages are translations of the original instructions.

The user manual does not replace the necessary training that is required for all of this machine's operators. HAULOTTE® has compiled this manual to assist in safe and efficient operation of the products covered in the manual.

The manual must be available to all operators and must be kept in a legible condition. Additional copies can be ordered from HAULOTTE Services®.

Stay Safe and keep working with HAULOTTE®!

For online reference and to download the manuals for your machines HAULOTTE®, go to:

<https://www.e-technical-information.com>

Or, scan the QR Code below:



2 Responsibilities

2.1 Owner's responsibility

The owner (or hirer) has the obligation to:

- To inform operators of the instructions contained in the Operator's Manual.
- Follow local regulations regarding operation of the machine.
- Replace all manuals or labels that are missing or in poor condition. Additional copies can be ordered from HAULOTTE Services®.
- To establish a preventive maintenance program in accordance with the manufacturer's recommendations, taking into account the environment and severity of use of the machine.
- To perform periodic inspections in accordance with HAULOTTE® recommendations and local regulations.

All malfunctions and problems identified during the inspection shall be corrected before the aerial work platform is returned to service.

2.2 Employer's responsibility

The employer (or plant superintendent) is required:

- To train and check the training of users.
- To authorise the trained user(s) to use the machine.
- To inform and familiarize the operator with the local regulations.
- Forbid anyone from operating the machine if:
 - Under the influence of drugs, alcohol, etc.
 - Subject to fits, convulsions, dizziness, etc.

2.3 Trainer's responsibility

- The trainer must be qualified to provide training to operators in accordance with applicable local regulations.
- The training must include all of the instructions in this manual.
- The training must be given in an obstacle-free area until the trainee is considered competent as defined by the training program undertaken.

2.4 Operator's responsibility

The operator has the obligation to:

- Read and understand the contents of this manual and familiarize himself/herself with the decals affixed on the machine.
- To inspect the machine before use according to HAULOTTE®'s recommendations..
- Inform the owner (or hirer) if the manual or any decals are missing or are not legible.
- Inform the owner (or hirer) of any machine malfunction.

Operators must ensure that the inspections have been carried out by the owner and that they can use the machine for the purpose intended by the manufacturer.



All users (driver, passenger, maintainer, transporter, etc.) must familiarise themselves with the emergency controls and machine operation in case of an emergency.

The operator has the obligation to stop using the machine in the event of malfunction or safety problems on the machine or in the work area and report the problem immediately to his/her supervisor.

3 Safety

3.1 Safety instructions

3.1.1 Incorrect use

- Do not use the machine outside of the conditions specified in this manual.
- Do not use the machine as a crane, material lift or elevator.



- Do not use the work platform as a hoisting machine (crane) by suspending a load outside of the platform.
- Do not tie the boom or platform to an adjacent fixed or mobile structure.
- Do not use/operate the machine when alone. A survey person or immediate Supervisor must be present on the ground in case of emergency.
- Do not use a faulty or poorly maintained machine. Remove defective/damaged machine from service.
- Do not climb onto the compartment covers of the machine.
- Do not replace items critical to machine stability with items of different weight or specification.
- Do not replace the wheels installed in the factory with wheels with different characteristics
- Do not alter or disable machine components that in any way affect safety and stability.
- Do not disable the safety devices.
- Do not use the machine if a label is missing or illegible.
- Do not damage, modify or hide machine labels or inscriptions.

3.1.2 Falling Hazards

N.B.-:THE GUARDRAIL IS THE MAIN PROTECTION SYSTEM AGAINST FALLS FROM THE MOBILE LIFTING PLATFORM (PEMP) .

Before commencing operation:

- Ensure that guard rails are correctly installed and secured.
- Ensure that gate or sliding bar is in its securely locked position.
- If using a machine that has a swing gate, check that the entry gate closes by itself and gate latches and locks.



- Remove oil or grease from the steps, floor, handrail and the guardrails.
- Clean the floor of the platform (no debris).

To enter or exit from the platform:

- The machine must be completely stowed (Access position) .
- Face the machine to access the opening to the platform.
- Keep 3 points of contact on the steps and the guardrail.
- Keep fingers away from moving parts near entry gate.



A - Foreword

When in the platform:

- Where personal fall protection equipment (FPE) is required by the employer, a competent authority or local regulations, we recommend using a full harness with a safety line.
- Personal fall protection equipment must only be fastened to approved fall protection anchoring points on the platform provided for this purpose.
- Refer to this decal located on the platform.
- Safety lines must never be attached to an object or structure outside of the work platform.
- Hold on securely to the guardrails.
- Always keep your feet firmly on the floor of the platform.
- Do not sit, stand, or climb on the platform guard rails.
- Do not lean on the gate or sliding bar.
- Do not lean over the guard rails or climb over them. Only work in the platform area within the guard rails.
- Do not exit the platform until it is in the completely stowed position.
- Do not use the guardrail as a means of access to climb in or out of the platform.

**3.1.3 Overturning / Tip-over Hazards****Before positioning and operating the machine:**

- Ensure that the surface is capable of supporting the machine weight including the rated capacity. Check the load bearing capacity of the supporting ground.  B 4.1 - Technical characteristics.
- Remain vigilant of driving direction reversal at the platform. Check the direction of movement with the help of the red or white arrows on the chassis and on the platform control box.
- Do not exceed the maximum rated capacity that includes the weight of both material and allowed number of occupants. Do not exceed the allowable number of occupants.
- Do not increase the working height (using extensions, ladder, etc.).
- Do not place ladders or scaffolds in the platform or against any part of this machine.
- Position loads uniformly in the centre of the work platform.
- Do not use the machine at wind speeds that are above the permissible threshold. Refer to the display on the work platform to view the permissible wind speed.
- Do not increase the surface area of the platform exposed to wind. This includes adding panels, mesh, banners. Failure to follow this instruction may lead to a loss of stability and as a result, the machine could tip over.
- Do not raise the platform or move the machine with the platform raised on a slope with a gradient greater than the machine's permissible limit.
- Do not rotate the turret while on a slope greater than 25%.



A - Foreword

- Do not drive the machine on slopes or grades exceeding the specified limits.



- Do not replace components critical to stability with components of different weight or specification.
- Do not use the machine with material or objects hanging from the guardrail or the boom.



- Do not pull or push towards any object outside of the platform. Do not exceed the maximum allowable side force stated in the performance specifications.
- Do not use the machine to support any external structure.
- Do not use the machine to tow other machines or to drag materials.

Using the machine on a slope:



Do not drive the machine on slopes with gradients exceeding the authorised transversal and lateral limits for the machine  B 4.1 - Technical specifications.

WIND: the aerial work platform can be used up to the maximum wind speed indicated in the specifications in this manual. To identify the local wind speed, use the Beaufort scale below, a wind gauge or an anemometer.

N.B.:--THE BEAUFORT SCALE OF WIND FORCE IS ACCEPTED INTERNATIONALLY AND IS USED WHEN COMMUNICATING WEATHER CONDITIONS. A WIND SPEED RANGE AT 10 M (32 FT 9 IN) ABOVE FLAT, CLEAR LAND IS ASSOCIATED WITH EACH DEGREE.

Beaufort scale

Force	Meteorological description	Observed effects	m/s	km/h	mph
0	Calm	Smoke rises vertically.	0 - 0,2	0 - 1	0 - 0,62
1	Very light breeze	Smoke indicates the wind direction.	0,3 - 1,5	1 - 5	0,62 - 3,11
2	Light breeze	Wind felt on the face. Leaves rustle. Weather vanes turn.	1,6 - 3,3	6 - 11	3,72 - 6,84
3	Slight breeze	Leaves and small twigs in constant motion. Flags move slightly.	3,4 - 5,4	12 - 19	7,46 - 11,8
4	Nice breeze	Raised dust and loose papers. Small branches are moved.	5,5 - 7,9	20 - 28	12,43 - 17,4

Force	Meteorological description	Observed effects	m/s	km/h	mph
5	Nice breeze	Small trees in leaf to sway. Crested wavelets form on inland waterways.	8,0 - 10,7	29 - 38	18,02 - 23,6
6	Cool wind	Large branches in motion. Power lines and chimneys 'sing'. Umbrellas used with difficulty.	10,8 - 13,8	39 - 49	24,23 - 30,45
7	Near gale	Whole trees in motion. Inconvenience felt when walking against wind.	13,9 - 17,1	50 - 61	31 - 37,9
8	Gale	Some branches break. Generally we cannot walk against the wind.	17,2 - 20,7	62 - 74	38,53 - 45,98
9	Strong gale	The wind causes slight damage to buildings. Tiles and chimney stacks are blown off.	20,8 - 24,4	75 - 88	46,60 - 54,68

3.1.4 Risk of electric shock (electrocution)



Risk of death or serious injuries.

The machine is not electrically insulated and does not provide protection from contact or proximity to electrically charged conductors.

Always position all parts of the aerial work platform, the occupants, accessories and tools at a reasonable distance from power lines to ensure that no part of the work platform accidentally comes into contact with a power line.

Apply the local regulations or those of the employer with regard to the safety distances. If this is not possible, follow the distances in the table below at a minimum:

Minimum safe approach distances

Electric voltage	Minimum safety distance	
	Mètre	Feet
0 - 300 V	Avoid contact	
300 V - 50 kV	3	10
50 - 200 kV	5	15
200 - 350 kV	6	20
350 - 500 kV	8	25
500 - 750 kV	11	35
750 - 1000 kV	14	45

A - Foreword

- Do not operate the machine when close to live power lines, consider the movement of the machine and the sway of the electric power lines particularly in windy conditions.
- Do not operate the machine during lightning, thunderstorms, snow/ice or any weather condition that could compromise operator safety.
- Do not use the machine as a ground for welding.
- Do not weld on the machine without first disconnecting the battery terminals.
- Always disconnect ground cable first.
- The machine must not be used while charging the batteries.
- When using the AC power supply, ensure it is protected with a circuit breaker and residual current device.
- Never expose the batteries or electrical components to water (high pressure washer, rain).



Keep away from the machine if it contacts energized power lines. Personnel on the ground or in the platform must not touch or operate the machine until energized power lines are shut off.



The user must not leave the platform if it comes into contact with a power line.

3.1.5 Explosion / Fire Hazards

- Always wear protective clothing, glasses or a face protection shield and gloves when working on batteries or energy sources.

N.B.: -ACID IS NEUTRALIZED WITH SODIUM BICARBONATE AND WATER.



- Do not start the engine if you smell or detect liquid propane gas (LPG), gasoline, diesel fuel or other explosive substances.
- Do not work on or operate a machine in an explosive or flammable atmosphere / environment.
- Do not touch hot components.
- Do not bridge the battery terminals with metallic objects.



- Do not service the battery in proximity of spark, open flame, lit cigarettes.
- Do not open the batteries.
- Do not fill the fuel tank with the engine running, close to naked flames and/or while smoking.







3.1.6 Crushing / Collision Hazards



Before using the machine, mark out the machine's work and circulation area using a marking system appropriate to the task at hand and the work environment.

A - Foreword

When in the platform:

- Check the work area for overhead clearance, for any obstacles besides and below the platform when raising/lowering the platform and or before driving.
- 
- 
- During movement, keep all the parts of the body inside the platform. Hold onto the guardrails on the opposite side to any surrounding structures.
 - To position machine close to a building/structure, it is recommended using the upper boom and or arms movement control functions to position, rather than driving machine closer to structure.
- 
- Warn personnel not to work, stand, or walk under a raised boom/platform.
 - Be aware of the boom position and tail swing when rotating the turret (turntable).
 - Always ensure that the chassis is never kept any closer than 1 m (3 ft 3 in) to holes, bumps, slopes, obstructions, debris and ground coverings that may hide holes and other dangers.
 - Maintain a distance of at least 1 m (3 ft 3 in) or any signs on the worksite.
 - Keep non-operating personnel at least 5 m (16 ft 5 in) away from the machine when driving and slewing.
 - Become familiar with the driving direction.
 - When turret is slewed/rotated 180°, the platform is now facing the rear of the machine.
 - Check the direction of movement with the help of the red or white arrows on the chassis and on the platform control box.
 - Also note that when changing the driving direction (Forward <> Reverse) the joysticks or switches must return to the neutral position before reversing the drive direction and for movement to occur.
- 
- When driving, position the platform so as to provide the best possible visibility and to avoid any blind spots.
 - Hold on securely to the guardrails.
 - **Personal Protection Equipment (EPI) :**
 - The occupants of the aerial work platform must wear personal protection equipment and comply with local regulations in force.
 - Operators must comply with the safety standards of the job site and the employer, as well as the applicable state regulations relating to the use of personal protective equipment.
 - All personal fall protection equipment (PFPE) must comply with current regulations, must be inspected and used in accordance with the manufacturer's instructions.
 - Avoid contact with fixed or mobile obstacles (other machines).
 - Other machines (crane, aerial work platform, etc.) operating in the work area increase the risk of crushing or collision. Restrict the operation of machines moving within the aerial work platform work area.
 - Take into consideration the stopping distance, reduced visibility and blind spots of the machine.
 - Limit travel speed to suit the ground surface condition, slope (incline), and people in the vicinity.

3.1.7 Risk of involuntary movements

Never use a damaged or malfunctioning machine.

Always respect the following rules:

- Maintain clearance from high voltage lines.
- Maintain clearance from generators, radar, electromagnetic fields.
- Never expose the batteries or electrical components to water (high pressure washer, rain).

4 Safety inquiries

Inquiries relating to design criteria/specifications of a product, standards compliance, or overall machine safety should be sent to the HAULOTTE® PRODUCT SAFETY department.

Each inquiry or request should include all relevant information; including contact name, telephone number, mailing address, email address, plus the machine model and serial number.

The HAULOTTE® Product Safety department will evaluate each request/inquiry and will provide a written response.

5 Incident notification

Notify HAULOTTE® immediately when a HAULOTTE® product has been involved in an incident/accident leading to personal injury or death, or when there is a major property damage.

HAULOTTE Group - EUROPE Product Safety Department

Address: Rue Emile Zola - 42420 Lorette - France

Tel: +33 (0)4 77 29 24 24

Email: productsafety.europe@haulotte.com

HAULOTTE Group - Australia, India and Asia Product Safety Department

Address: No.26 Changi North Way - Singapore 498812 - Singapore

Tel: +65 6546 0123

Email: productysafety.apac@haulotte.com

HAULOTTE Group - North & South America Product Safety Department

Address: 3409 Chandler Creek Rd. - Virginia Beach, VA 23453 - United States

Tel: +1 757 689 2146

Email: productsafety.americas@haulotte.com

Connect to our website: www.haulotte.com



6 Compliance

6.1 Product modification

It is strictly forbidden to modify a HAULOTTE® product. Any modification may violate Haulotte design parameters, local regulations and industry standards.

Any requests for modification must be formulated in writing (form) and be approved by the manufacturer.

Do not hesitate to contact HAULOTTE Services®, should you have any questions relating to the issued bulletin(s) or with questions on the policy itself.

6.1.1 Implementing manufacturer safety campaigns

It is essential to implement the safety campaigns issued by the manufacturer. All of these campaigns are accessible on our website.

Connect to our website: www.haulotte.com



Never market (or sell) a machine without first having carried out all of the safety campaigns.

6.2 Product specifications

HAULOTTE® cannot be held liable for any changes to the technical characteristics/specifications contained in this manual. HAULOTTE® has a continuous improvement policy in place for its product range. Given this policy, the Company reserves the right to modify products technical characteristics / specifications without notice.

6.3 Change of Ownership Notification

It is important and necessary to keep HAULOTTE Services® updated with current ownership of the machine. This way, HAULOTTE® will be able to provide the necessary support for the product. If you have sold or transferred this machine(s); it is your responsibility to notify HAULOTTE Services®. It is not required to include Lessees/Renters of Leased/Rented machines on this form.

Connect to our website: www.haulotte.com

A - Foreword



6.4 Declaration of conformity



The CE declarations of conformity only apply to machines that have been approved and commissioned within the European Community (EC).

6.4.1 Declaration of conformity - All machines



The UKCA declarations of conformity only apply to machines that have been approved and commissioned within the United Kingdom (UK).

Declaration of conformity - UKCA and CE directive



UKCA / EC DECLARATION OF CONFORMITY

HAULOTTE Factory



Declares under our own responsibility that the machine described below :

Mobile Elevating Work Platform

Commercial name
Type
Serial number

Commercial name of the concerned machine
Model type of concerned machine
Serial number of the machine

Conforms with provisions of the Regulations listed below :

CE

EC Machinery Directive 2006/42/CE
EC Directive electromagnetic compatibility 2014/30/EU
EU RED Directive on radio equipment (if machine equipped) 2014/53/UE

UKCA

Supply of Machinery (safety) 2008 SI2008/1597 amended SI2011/1043/2157 2019/696
Electromagnetic compatibility 2016 SI 2016/1091 amended SI 2017/1206, 2019/696
Radio equipment (if machinery equipped) 2017

This machine has been type examined by :

Name of the Authorized body :

Name of the Approved body :

Certificate number :

Certificate number :

Harmonized standard(s) used as reference(s) :
EN280

Designed standard(s) used as reference(s) :
BS EN280

Person authorised to compile the technical file :

HAULOTTE GROUP
Compliance Manager
RUE EMILE ZOLA
CS 30045 42420 LORETTE FRANCE

HAULOTTE UK Ltd
General Manager UK and Ireland
Unit 1 Gravelly Way, Four Ashes
Wolverhampton, West Midlands WV10 7GW
ENGLAND

Name and Signature
Division Director

Date and place

haulotte.com 

777365830192340017NW2591PF-02
NW25910H-CE-UKCA-V2.0.5

6.4.2 Declaration of conformity - Thermal platforms

Declaration of conformity - CE directive



DECLARATION CE DE CONFORMITE
(EC DECLARATION OF CONFORMITY)



Fabricant et personne autorisée à constituer le dossier technique <i>(Manufacturer and the person authorised to compile the technical file.)</i>	Compliance & Regulation Director HAULOTTE GROUP S.A. RUE EMILE ZOLA
HAULOTTE GROUP	42420 LORETTTE FRANCE
Adresse du site de production <i>(Address of the Division)</i>	Nacelle élévatrice de personnel <i>(Mobile Elevating Work Platform)</i>
en conformité avec le modèle type <i>(In compliance with the Model Type)</i>	Modèle type de la machine concernée <i>(Type model of the concerned machine)</i>
Nom commercial <i>(Commercial name)</i>	Nom commercial de la machine concernée <i>(Commercial name of the concerned machine)</i>
Numéro de série <i>(Serial number)</i>	Numéro de série de la machine <i>(Serial number of the machine)</i>
Organisme notifié <i>(Notified body)</i>	Nom et adresse de l'organisme notifié <i>(Name and address of notified body)</i>
Numéro de certificat <i>(Certificate number)</i>	Numéro de certificat du type de machine <i>(Certificate number of the type of machine)</i>
Charge maximale d'utilisation <i>(Rated capacity)</i>	Charge maximale d'utilisation de la machine concernée <i>(Rated capacity of the concerned machine)</i>

Nous déclarons que cette machine est conforme aux dispositions des Directives suivantes
(We hereby declare that this machine conforms with all the relevant provisions of the Directives listed below)

Directive CE Machine <i>(EC Machinery Directive)</i>	2006/42/CE
Se conforme aux principales exigences de la norme harmonisée <i>(This machine also fulfils the principles of the harmonised standard)</i>	EN290
Directive CE concernant la compatibilité électromagnétique <i>(EC Directive on electromagnetic compatibility)</i>	2014/30/EU
Directive CE RED concernant les équipements radioélectriques (machine équipée) <i>(RED EC Directive on radio-electrical equipment (machine equipped))</i>	
Directive CE d'émission de bruit <i>(EC Outdoor Noise Directive)</i>	2000/14/EC
Méthode de mesure <i>(Measurement method)</i>	Annex III-B
Niveau de puissance acoustique garanti <i>(LWA, Guaranteed sound level)</i>	101 dB
Niveau de puissance acoustique mesuré max <i>(LWA, Maximum sound level)</i>	99 dB

Cette déclaration porte exclusivement sur la machine dans l'état où elle a été placée sur le marché
(This declaration relates exclusively to the machinery in the state in which it was placed on the market)

Toute modification de la machine décrite ci-dessus a pour effet d'invalider cette déclaration
(Any modification to the above described machine violates the validity of this declaration)

Nom et signature du Directeur du site de production <i>(Name and signature of the Division Director)</i>	Lieu <i>(Place)</i>
	Date <i>(Date)</i>

haulotte.com 

B - Familiarization

1	General safety.....	3
1.1	Intended use.....	3
1.2	Decal content.....	3
1.3	Level of severity.....	4
1.4	Symbols legend and definitions.....	5
1.5	Symbols and colors.....	7
2	Models description.....	8
3	Primary machine components.....	9
3.1	Description.....	9
3.2	Ground control box - Service / Emergency station.....	11
3.3	Platform control box - Main station.....	32
4	Performance Specifications.....	37
4.1	Technical characteristics.....	37
4.2	Engine specifications.....	43
4.3	Working area / Range of motion.....	45
5	Decals and markings locations.....	46

B - Familiarization

1 General safety

1.1 Intended use

Do not operate the product in the following situations:

- On soft, unstable or cluttered ground.
- With wind blowing faster than the permissible limit:
 - Check the allowable wind speed specified in the performance specifications tabulation.
 - Consult the Beaufort scale.
- Close to power lines. Keep a safe distance.
- If the machine is stored at a temperature out of range : From - 20°C (- 4°F) to + 50°C (+ 122°F).
- In an explosive atmosphere / environment.
- During storms.
- In the presence of strong electromagnetic fields.

N.B.-:USE THE MACHINE UNDER "NORMAL" CLIMATIC CONDITIONS. IF YOU NEED TO USE THE MACHINE IN CLIMATIC CONDITIONS LIKELY TO CAUSE DETERIORATION (EXTREME : HUMIDITY, TEMPERATURES, SALINITY, CORROSIVENESS, ATMOSPHERIC PRESSURE), CONTACT HAULOTTE SERVICES®. REDUCE INTERVALS BETWEEN SERVICING.

N.B.-:IN HARSH ENVIRONMENTS (HIGH LEVELS OF SALINITY IN THE ATMOSPHERE: CLOSE TO THE SEA, INDUSTRIAL ENVIRONMENT WITH CHLORIDE EMISSIONS AND/OR HUMIDITY > 70%), WE RECOMMEND APPLYING SOLVENT-BASED OIL TO THE ENTIRE MACHINE.

1.2 Decal content

The purpose of the labels on the machine is to alert the user to the conditions of use and risks related to aerial work platforms.

Decals provide the following information:

- The level of severity.
- The specific hazard.
- A method to avoid, suppress or reduce the hazard.
- Descriptive text (where required).

Familiarize yourself with the decals and the hazard severity levels.

The decals must be kept in good condition. Promptly replace all decals that are no longer legible.

Familiarize yourself with the decals and their respective color codes.

Additional decals can be ordered from HAULOTTE Services®.

CE, UKCA, AS and EAC standards













ANSI and CSA standards



B - Familiarization

Marking	Description
1	Risk identification symbol
2	Level of severity
3	Avoidance symbol pictorial
4	Avoidance text

1.3 Level of severity





















Color	Title	Description
		Danger: Indicates a hazardous situation which if not avoided, WILL result in death or serious injury.
		Warning: Indicates a hazardous situation which if not avoided, COULD result in death or serious injury.
		Caution: Failure to comply could result in minor or moderate injury.
		Notice: Indicates recommended practices if not followed, may result in a malfunction or damage the machine or its components.
		Procedure: Indicates a maintenance operation.

B - Familiarization















1.4 Symbols legend and definitions

Symbols are used throughout this manual to depict hazards, avoidance measures and indicate when information is required.

Refer to the following table to familiarize yourself with these symbols.

Symbol	Description	Symbol	Description	Symbol	Description
	Risk of crushing or pinning		Foot crushing hazard		High pressure fluid ejection hazard
			Hand crushing hazard		Crushing hazard
			Health/safety hazards related to chemicals		Burn hazard
	Risk of electrocution		Burns and scalds from contact with flames, explosion or radiation from heat sources		Injury from Electric arcs - Energy supply disconnecting devices - Batteries fire, emissions, etc
	Fall hazard		Tip over due to excessive loading / wind load and excessive ground slope		Relate and coordinate directional arrows on the chassis with those on the control box
	Do not put foot in this area		Do not put your hand in this area		Keep away from product working area
	Use of high-pressure cleaners prohibited		Ensure entry drop rail is down		

B - Familiarization







Symbol	Description	Symbol	Description	Symbol	Description
	Flames prohibited		Maintain safe clearance from high voltage electrically charged conductors as described in manual - Do not use in thunderstorms		Overload
	Refer to operator manual		Safety belt		Use appropriate lanyard attached to dedicated anchor point.
	Wheel pressure		Enable switch		Use safety prop before attempting any maintenance work
	Tow point		Tie down point		Lift point
	Keep away from hot surfaces		Wear protective equipment		

B - Familiarization

1.5 Symbols and colors

Symbols and colors are used to alert the operator of safety precautions and/or to highlight important safety information.

The following safety symbols are used throughout this manual to indicate specific hazards and the hazard severity level when operating or maintaining the Aerial Work Platform.

Symbol	Description
	Danger: Risk of injury or death
	Caution: Risk of material damage
	Prohibited action
	Reminder to use good practice or follow pre-operation checks
	Cross-reference to another part of the manual
	Cross-reference to another manual
	Cross-reference to repair (contact HAULOTTE Services®)
N.B.:	Additional technical information

B - Familiarization**2 Models description**

Models	Regulations						
	CE	UKCA	ANSI	CSA	EAC	AS	JIS
HA16RTJ	✓	✓	✗	✗	✓	✓	✓
HA16RTJO	✓	✓	✗	✗	✓	✓	✓
HA16RTJ PRO	✓	✓	✗	✗	✓	✓	✓
HA46RTJO	✗	✗	✓	✓	✗	✗	✗
HA46RTJ PRO	✗	✗	✓	✓	✗	✗	✗

Legend

✓	Available
✗	Not available

B - Familiarization

3 Primary machine components

3.1 Description

HA16RTJ - HA16RTJ O - HA16RTJ PRO - HA46RTJ O - HA46RTJ PRO

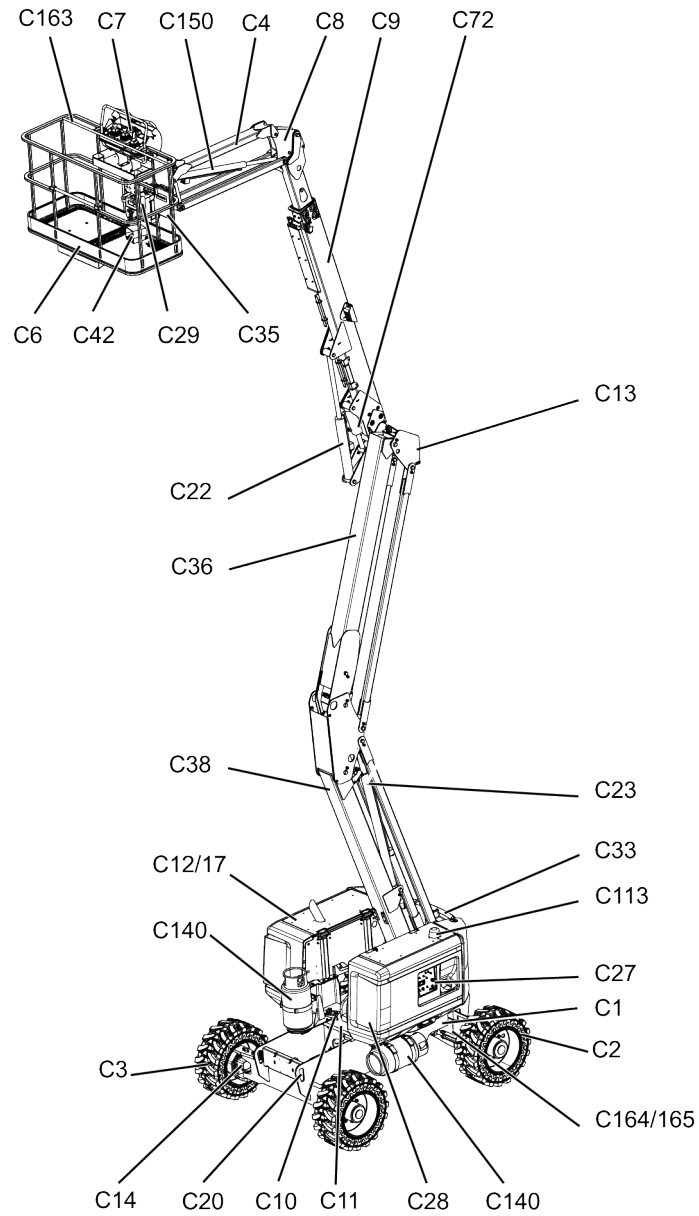

B - Familiarization

Marking	Description	Marking	Description
C1	Chassis	C23	Arm lifting cylinder
C2	Front driven steering axle	C27	Ground control box+Universal plug
C3	Rear drive wheel (and steer wheel if 4WS)	C28	Tilt sensor
C4	Jib	C29	Platform rotation cylinder
C6	Platform	C33	Counterweight
C7	Platform control box	C35	Document holder
C8	Input jib leveling cylinder	C36	Top arm
C9	Upper boom	C38	Bottom arm
C10	Slew ring	C42	Foot Switch
C11	Turntable assembly	C72	Output jib compensation cylinder
C12	Right side compartment	C113	Beacon light
C13	Arm/Boom link piece	C140	Propane bottles- (For ANSI / CSA standard only)
C14	Hydraulic drive motor and reducer	C150	Jib lifting cylinder
C17	Left side compartment (engine, pump and starter battery)	C163	Handrail
C20	Tie-down (and/or lifting) points	C164	Front steering axle
C22	Boom lift cylinder	C165	Front steering and oscillating axle (For HA16RTJO / HA16RTJPRO / HA46RTJO / HA46RTJPRO only)

Universal plug



B - Familiarization

3.2 Ground control box - Service / Emergency station





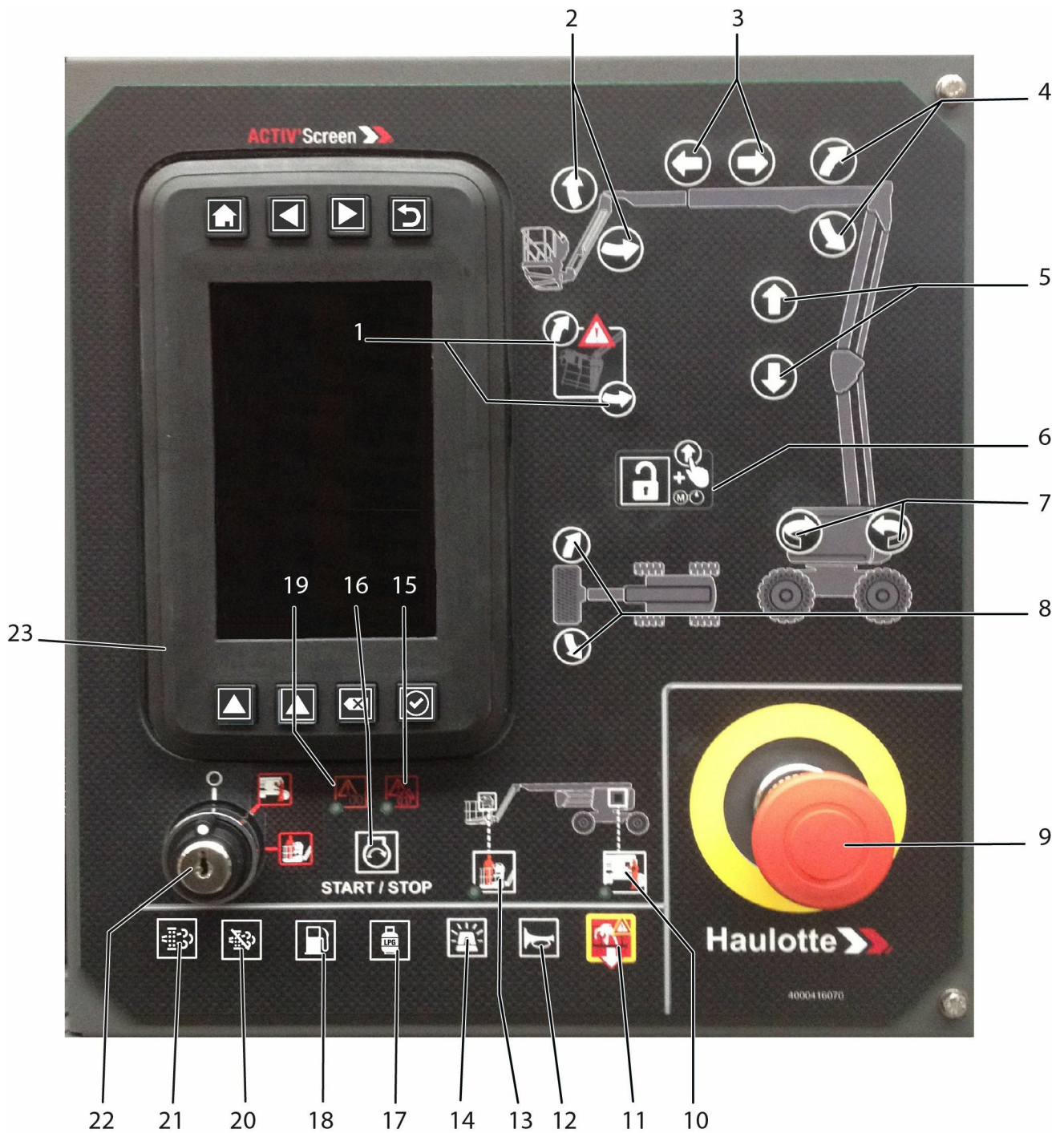





3.2.1 Layout-Color screen display

General view









B - Familiarization

Controls and indicators







Marking	Name	Description	Function
1	SA720U	Platform tilt control	By pressing on  : Tilt the platform towards the front of the machine
	SA720D		By pressing on  : Tilt the platform towards the back of the machine
2	SA620U	Jib lifting / lowering switch ⁽¹⁾	By pressing on  : Jib lifting
	SA620D		By pressing on  : Jib lowering
3	SA530O	Boom telescoping switch	By pressing on  : Boom extend
	SA530I		By pressing on  : Boom in
4	SA520U	Boom raising switch	By pressing on  : Boom raising
	SA520D		By pressing on  : Boom lowering
5	SA420U	Arm lifting switch	By pressing on  : Arm raises
	SA420D		By pressing on  : Arm lowers
6	SB800	Enable Switch/Back-up unit selector	By pressing on  <ul style="list-style-type: none"> - Validation of controls when engine started - Automatic switching of emergency electropump if the engine is stopped

(1) For machines fitted with





B - Familiarization

Marking	Name	Description	Function
7	SA250L	Turntable rotation switch	By pressing on  : Counter clockwise (CCW) rotation
	SA250R		By pressing on  : Clockwise (CW) rotation
8	SA750L	Platform rotation switch	By pressing on  : Clockwise (CW) rotation
	SA750R		By pressing on  : Counter clockwise (CCW) rotation
9	SB801	Emergency Stop button	Pulled out: Ground control box energized
			Pushed in (activated): De-energizes control system
10	HL905	Indicator of the ground control box selection	LED lights up - ground control box icon
11	SA801	Overriding system control	By pressing on  : Authorize movements from the ground control box in case of overload (Use ONLY in case of emergency)
12	SB807	Horn button	By pressing on  : Horn activation
13	HL906	Indicator of the platform control box selection	LED lights up - platform control box icon
14	SA903	Beacon light on/off	By pressing on  : Beacon light ON / OFF

B - Familiarization

Marking	Name	Description	Function
15	HL909	Overload indicator/ Fault	 <p>Alarm icon</p> <ul style="list-style-type: none"> - Is ON at power up of the machine, at the same time as the icon (19) - Is blinking if overriding is active <ul style="list-style-type: none"> • An active or detected failure is displayed on on-board screen • Or Hydraulic oil temperature icon is active on on-board screen • Or Engine pressure icon is active on on-board screen • Or Engine stop icon is active on on-board screen • Or Overload machine status is active on on-board screen
16	SA303	Engine start-up selector	By pressing on  : Engine start / stop
17	SA300	Propane Gas supply	By pressing on  : Propane Gas supply selection
18	SA305	Petrol/Gasoline or diesel supply	By pressing on  : Fuel supply selection
19	HL908	Engine warning indicator/Engine pre-heating	 <p>Alarm icon</p> <ul style="list-style-type: none"> - Is ON at power up of the machine at the same time as the icon (15) - Is blinking if overriding is active Warning icon is ON if <ul style="list-style-type: none"> • Engine warning icon is active on on-board screen • Or Tilt machine status is active on on-board screen • Or Engine is pre-heating
20	SA600F	DPF regeneration inhibited	By pressing on  : Refusal of the request for regeneration

B - Familiarization

Marking	Name	Description	Function
21	SA600D	DPF regeneration required	By pressing on  : Regeneration start-up
22	SA900	Control box activation key switch	 : De-energizes control system
			 : Platform control box energized
			 : Ground control box energized
23		Activ'Screen 2	

B - Familiarization

3.2.2 HAULOTTE Activ'Screen 2









Upon starting and during operation of the machine, the LCD screen Activ'Screen located on the ground control box displays in real time the machine operating status.

HAULOTTE Activ'Screen 2

Icon	Description	Function	Icon	Description	Function
HAULOTTE Activ'Screen 2					









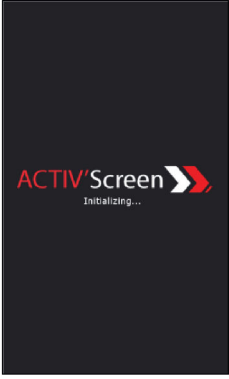
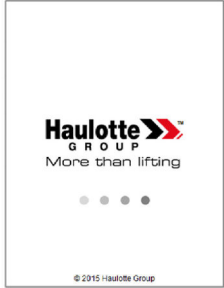

Navigation buttons - Above Activ'Screen display

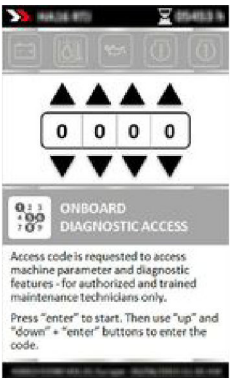
	Home Button	Allows return to the home screen at any time		Up Navigation	Permits scrolling up through the screen (if present)
	Left navigation	Permits navigation to screens to the left (if present)		Down Navigation	Permits allows scrolling down through the screen and onto the following screen (if present)
	Right Navigation	Permits navigation to screens to the right of the current screen (if present)		Cancellation button	Used to refuse or cancel a selection within the menu
	Back button	Returns you to the previous screen		Validation Button	Used to confirm selection within the menus



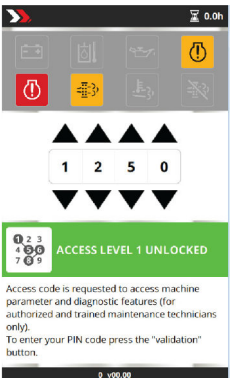

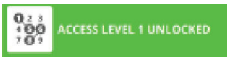
B - Familiarization



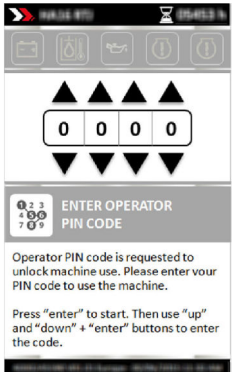

Icon	Function
When the machine is first started up after 3 days of inactivity, or if the battery has been disconnected, the following screens are displayed in order	

	Machine power up (Start-up screen)
	

Icon	Function	Icon	Description
	Access code (Will be visible - depending on the machine)		Access code not yet entered
			Access code entered is correct (Level 1, 2 or 3 depending on authorization of technician)
			Access code entered is incorrect
	NIV 1 diagnostic access code (Will be visible - depending on the machine)	The machine can be personalized with a user identification code. Personalization is only possible with level 1 access	
		Machine properties display -:Soft version, machine serial number, adjustment parameters Possible change of parameters -:Language, fault display format, brightness setting, time, and some options availables	
			Operator PIN code not yet entered
			Operator PIN code entered is correct
			Operator PIN code entered is incorrect

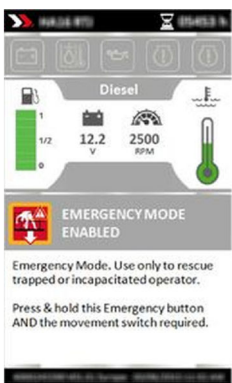
B - Familiarization

Icon	Function	Icon	Description
	Operator PIN code (Will be visible - depending on the machine)		Operator PIN code not yet entered
			Operator PIN code entered is correct
			Operator PIN code entered is incorrect

Icon	Function	Icon	Description
	Emergency mode		Emergency mode is activated when:- - Emergency Stop at platform control box has been pushed in (de-energized) - The machine is in overload state - Ground control box is selected - The emergency overriding button is activated
			Emergency mode is deactivated when:- - The Emergency Stop at platform control box is pulled out (energized) - The machine is NOT in overload state - Ground control box is NOT selected/energized
			The Emergency mode is out of service/non-functional
			Emergency mode has been used and activation of its function saved in the memory of the machine A HAULOTTE® certified technician is required to reset the Emergency Mode system



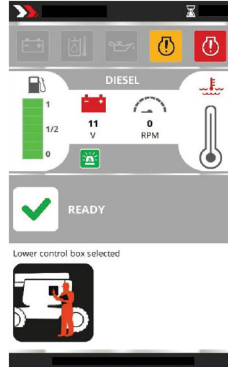

B - Familiarization

Icon	Function	Icon	Function	Description
Home screen (dashboard) - Will be visible - depending on the machine				

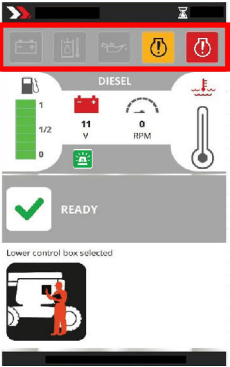
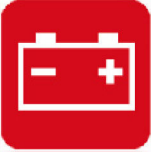

	Machine model zone		Machine model	Machine model display
	Hour meter/next maintenance zone		Hour meter	The timer flashes if the engine is switched on and the hourmeter increases
			Maintenance use	The Maintenance Tool icon and the number of hours remaining until the next maintenance are displayed for 5 seconds when the machine is started up. Maintenance Tool icon blinks; if maintenance is due.
				The maintenance tool icon turns RED when the next scheduled maintenance must be carried out in under 25 hours

B - Familiarization

Icon	Function	Icon	Function	Description
Home screen (dashboard) - Will be visible - depending on the machine				
	Warning icons zone		Battery status	Icon is ON if there is no charge output detected from the alternator. Icon is flashing if a failure code for the alternator is detected (code F09.10).
			Hydraulic oil temperature	Icon is ON when the temperature in the hydraulic reservoir has exceeded the maximum required temperature. Stop using the machine and allow the oil to cool down.
			Engine oil pressure	Icon is ON if engine oil pressure is lower than required limit while engine is running. The Engine must be switched OFF immediately to avoid damaging the motor.
			Stop engine	The icon is lit if engine failure is detected (coolant, oil pressure, alternator, etc.). Or if the Engine shuts down after 3 seconds of running. Or after 1 second when engine fails to start.

B - Familiarization

Icon	Function	Icon	Function	Description
Home screen (dashboard) - Will be visible - depending on the machine				

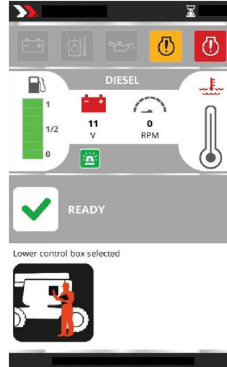

<p>Warning icons zone</p>		Engine warning	Icon is ON if Engine warning is detected Or one of the engine maintenance schedules has been exceeded.
		Engine decontamination fault (if fitted)	Engine decontamination system fault. In this case, you must contact HAULOTTE Service® as soon as possible.

B - Familiarization

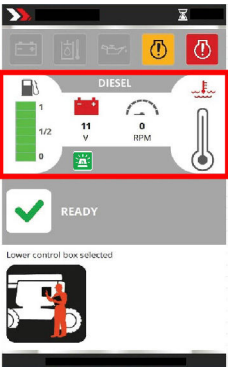
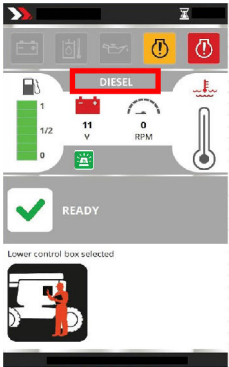
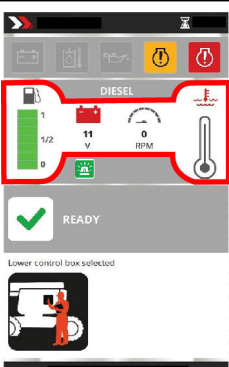
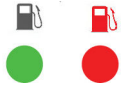
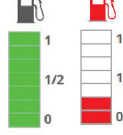
Icon	Function	Icon	Function	Description
Home screen (dashboard) - Will be visible - depending on the machine				
	Functional information zone		Power mode used	Diesel
			Bargraph	
			Digital Gauge - Fuel reserve indicator (ON/OFF)	The indicator changes from GREEN to RED when the fuel level is low and indicator is activated
			Analog Gauge - Fuel level gauge	The fuel level indicator switches from GREEN to RED when the fuel level is low

B - Familiarization

Icon	Function	Icon	Function	Description
Home screen (dashboard) - Will be visible - depending on the machine				

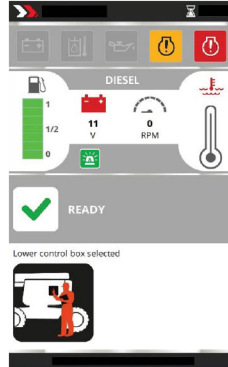

	Functional information zone		Battery charge Displays the machine battery voltage. The indicator switches to RED if the voltage is low.
			Engine speed Engine speed display
			Engine temperature Displays Engine coolant temperature. The indicator switches from GREEN to RED when the engine overheats.

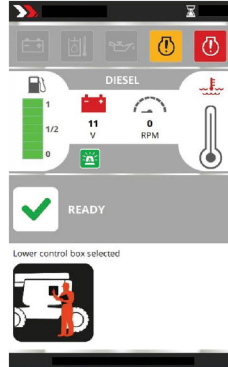

B - Familiarization

Icon	Function	Icon	Function	Description
Home screen (dashboard) - Will be visible - depending on the machine				





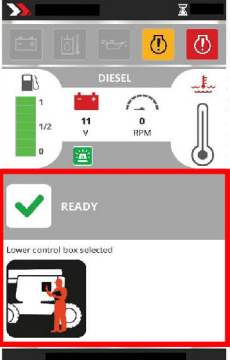
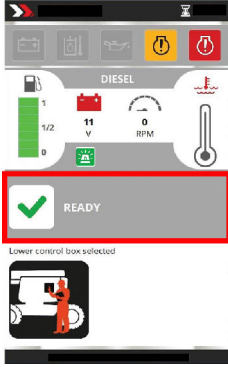

	Additional functions		Beacon light	The icon is ON when the flashing light is switched on
			Working light	The icon is ON when the work light is switched on
			Activ' System	Lighting The icon is ON when the Activ' Lighting System is switched on in auto or manual mode
			Stop System	Emission The icon is ON if the system is active on the machine



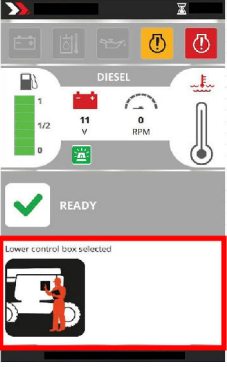



B - Familiarization

Icon	Function	Icon	Function	Description
Home screen (dashboard) - Will be visible - depending on the machine				
	Machine status zone		Pictogram and title	Displays the pictogram and machine status
			Ready	Machine ready, displayed when no failures and no other machine state icons is active
			Alarm	The alarm icon blinks in case of: <ul style="list-style-type: none"> - Machine failure - Failure detected - Machine in overload - Machine in tilt Another icon will be displayed to show the machine's status, the failure or the malfunction.

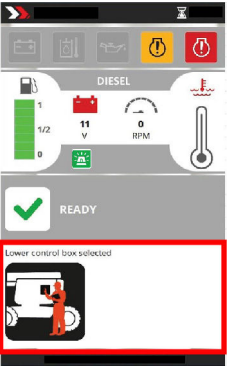





B - Familiarization

Icon	Function	Description
Home screen (dashboard) - Will be visible - depending on the machine		
	Description	
	Platform control box selected	Selector switch is in platform control box position
	Ground control selected	Selector switch is in ground control box position
	Tilt	<p>The machine is elevated , and is on a slope greater than the permitted slope.</p> <p>Depending on the machine configuration, the lifting and extension functions are slowed or stopped.</p>
	Overload	<p>The platform is overloaded.</p> <p>Remove the excessive load to or below the rated capacity, to restore functions.</p> <p>In case of an emergency, to rescue the operator in platform, use the Overriding system.</p>

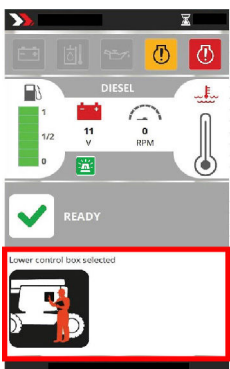
B - Familiarization

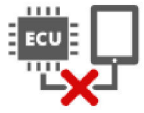
Icon	Function	Description
Home screen (dashboard) - Will be visible - depending on the machine		
	Description	
	Pre-heating	<p>Engine's automatic preheat system is active.</p> <p>The time to pre-heat will vary according to engine and ambient temperature.</p> <p>The machine can be started as soon as the indicator goes out.</p>
	Radius limitation	Icon is ON if the range limit is active or faulty
	Machine is charging	The machine is charging by the engine
Icon	Function	Description
Home screen (dashboard) - Will be visible - depending on the machine		
	Low fuel level	<p>Fuel level is low. Refill the fuel tank to the marked level.</p> <p>A lack of fuel may damage the engine and will not be covered by the warranty</p>
	Stop Emission System	Icon is ON when the function cuts the engine
	Activ' Lighting System	The function is off. To switch it on, go to the 'Settings' menu.

B - Familiarization

Icon	Function	Description
Home screen (dashboard) - Will be visible - depending on the machine		
	Description	
	Diagnostic in progress	The HAULOTTE Diag console is connected to the machine
	Screen software obsolete	Screen software update essential. Contact Haulotte Service®.
Icon	Function	Description
Home screen (dashboard) - Will be visible - depending on the machine		
	F12.01 Bus CAN fault	CAN network fault between the screen and the rest of the machine
	Activ' Shield Bar disable	The secondary safety system is switched off (If fitted)
	Activ' Shield Bar triggered	<p>The secondary safety system is triggered. An operator may be trapped on the platform:-</p> <ul style="list-style-type: none"> - In this situation, supervisor(s) at ground level must turn the control box key selector (22) to the ground control box  position to take control - The platform box controls are de-energized - Check that the Emergency Stop button (9) at ground is not pressed in - To safely activate movements from the ground control box, the Enable Switch (6)  must be pressed and held

B - Familiarization

Icon	Function	Icon	Function	Description
Home screen (dashboard) - Will be visible - depending on the machine				

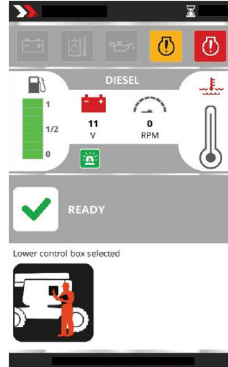





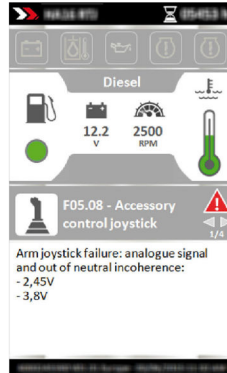

	General information zone		Machine software version and code	Displays the reference and version of the software installed on the machine
			Machine date and time	Displays the date and time of the machine ECU

B - Familiarization

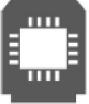









Icon	Function	Description	Icon	Function	Description
Machine fault - Will be visible - depending on the machine					

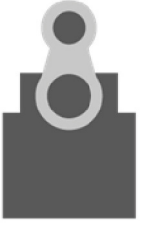

Machine fault icons (Please see machine configuration)

	Failure code F01.xx	Fault:-Variable speed calculator		Failure code F09.xx	Fault:-Internal combustion engine
	Failure code F02.xx	Fault:-Power contactor		Failure code F10.xx	Fault:-Functions
	Failure code F03.xx	Fault:-Command relay		Failure code F11.xx	Fault:-Machine safety

B - Familiarization

Icon	Function	Description	Icon	Function	Description
Machine fault - Will be visible - depending on the machine					
	Failure code F04.xx	Fault:-Solenoid valve		Failure code F12.xx	Fault:-ECU console
	Failure code F05.xx	Fault:-Joystick		Failure code F13.xx	Fault:-Switchs
	Failure code F06.xx	Fault:-Weighing system		Failure code F14.xx	Fault:-Driving pump
	Failure code F07.xx	Fault:-Limit switch or sensor		Failure code F15.xx	Fault:-CAN circuit
	Failure code F08.xx	Fault:-Electric circuit		Failure code F16.xx	Fault:-Electric motor

B - Familiarization

3.3 Platform control box - Main station



3.3.1 Layout

General view

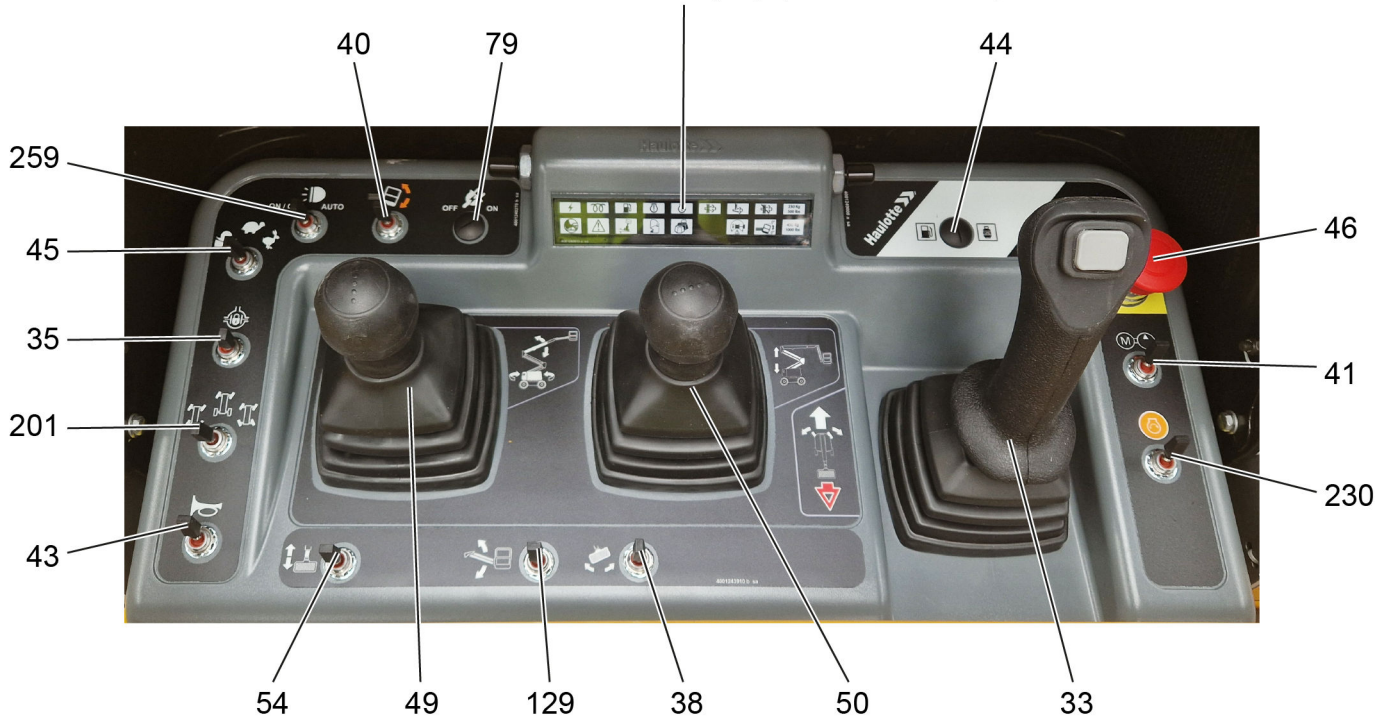
Affichage pupitre de commandes haut (Led 101 - 117)
 Platform control box display (Led's 101 - 117)





B - Familiarization**Controls and indicators**

Marking	Name	Description	Function
33	SM902	Drive joystick	Move forward: Forward drive
			Move backwards: Reverse drive
		Steering rocker switch	Press right side of button: Steer right-According to selected mode (201)
			Press left side of button: Steer left-According to selected mode (201)
35	SA100	Differential lock selector	Toggle left and hold (Activated) : Maximum drive torque (on difficult or sloping ground)
			Release (deactivated): Standard torque
38	SA751	Platform rotation switch	Move to the right: Counter clockwise (CCW) rotation
			Move to the left: Clockwise (CW) rotation
40	SA721	Platform leveling switch	Move upwards: Raise platform
			Move downwards: Platform lowers
41	SA800	Auxiliary power switch	Toggle and hold: Back-up unit activated
			Release: Back-up unit deactivated
43	SA907	Horn button	Push the horn selector down to sound the horn
			The horn stops when the selector switch is released
44	SA304	Fuel selector ⁽¹⁾	Push switch to the right for LPG (liquid propane gas supply)
			Push switch to the left for gasoline (petrol) or diesel fuel supply
45	SA110	Drive speed selector	 High-speed drive
			 Medium speed drive
			 Low-speed drive
46	SB802	Emergency Stop button	Pulled out: Platform control box energized
			Pressed in: De-energizes control system (Engine stopped)

(1) For machines fitted with

B - Familiarization







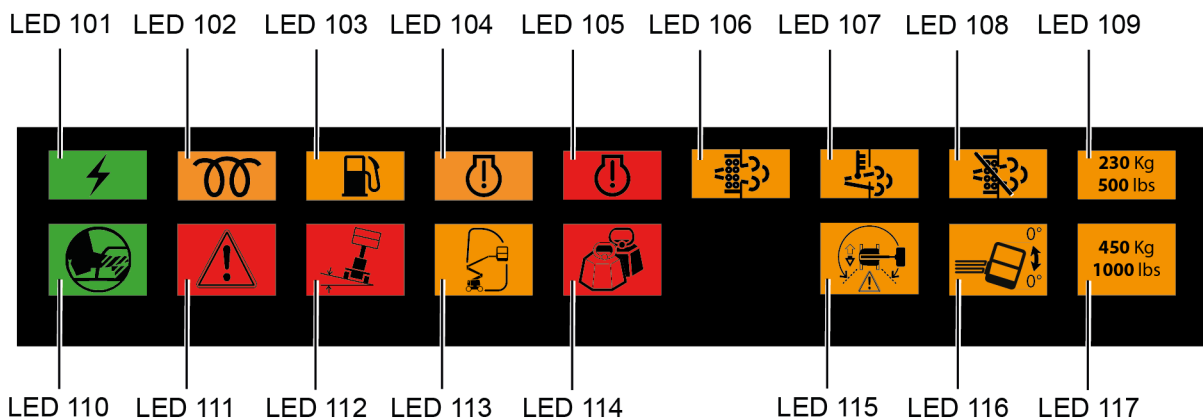



Marking	Name	Description	Function
49	SM900	Turntable rotation joystick	Move to the right: Counter clockwise (CCW) rotation
			Move to the left: Clockwise (CW) rotation
		Boom lift joystick	Move forward: Raise boom
			Move backwards: Lower boom
50	SM901	Arm lift joystick	Move forward: Arm raises
			Move backwards: Arm lowers
54	SA531	Boom telescoping switch	Hold upwards: Boom retracts
			Move downwards and hold: Boom extends
79	SA906	Generator selector ⁽¹⁾	Move to the left: Generator deactivated
			Move to the right: Generator activated
129	SA621	Jib raising / lowering switch ⁽¹⁾	Hold upwards: Lifting
			Move downwards and hold: Lowering
201	SA101	Steering mode selector ⁽¹⁾	Synchronised axle: 4 wheel steering mode
			2 front steering wheels from axle
			Crab mode axle
230	SA303	Engine start-up / stop selector	Move backwards: Starts or Stops the engine (depending on the engine's operating (ON/OFF) mode)
259	SA907B	Activ' Lighting System selector	 ON / OFF
			 AUTO Automatic lighting

3.3.2 Display Panel (LED'S 101 - 117)





Upper control box display

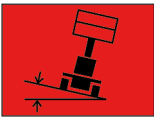
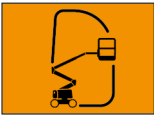

B - Familiarization

Marking	Name	Symbol	Function
LED 101	HL900		Machine switched on: <ul style="list-style-type: none"> - Rapid flashing: Machine is ON, but platform control box is not active but the ground control box is ON. Also flashes with either Emergency Stop pressed in - Illuminated: Machine is turned on and platform control panel is active.
LED 102	HL300		Combustion engine pre-heating: <ul style="list-style-type: none"> - Illuminated while engine is pre-heating - Off if engine started and if post-heating
LED 103	HL307		Low fuel level
LED 104	HL304		Engine warning: <ul style="list-style-type: none"> - Lighted in case of minor engine fault (e.g. water in the diesel, clogged air filter, etc.) - Lighted or flashing in case of fault managed by the engine ECU
LED 105	HL305		Engine shutdown: <ul style="list-style-type: none"> - Lighted in case of major engine fault (e.g. engine overheating, oil pressure, alternator fault, etc.) - Lighted in case of faults managed by the engine ECU
LED 106	HL301		Not used
LED 107	HL302		Not used
LED 108	HL303		Not used
LED 109	HL805		Not used
LED 110	HL807		Foot Switch: <ul style="list-style-type: none"> - Illuminated when Foot Switch activated - Blinks after 90 s of inactivity / Stop Emission System
LED 111	HL801		Faults: <ul style="list-style-type: none"> - Rapid flashing: If a fault is active (current fault)

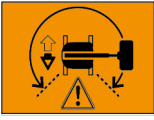
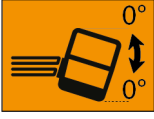
B - Familiarization

Marking	Name	Symbol	Function
LED 112	HL800		Tilt sensor: - Illuminated when in tilt, machine stowed or unfolded
LED 113	HL804		Not used
LED 114	HL802		Overload: - Rapid flashing: Faulty weighing / overload system - Illuminated when overloaded
LED 115	HL250		Not used
LED 116	HL720		Basket levelling +/- 10°: - Illuminated if the angle of the platform reaches +/- 10° in relation to the horizontal and movement control
LED 117	HL806		Not used

B - Familiarization

4 Performance Specifications

4.1 Technical characteristics

Use the table to select the right Haulotte machine for the job.



Do not replace parts that are essential to the stability of the machine, such as batteries or tyres, with parts that have a different weight or different specifications. The stability of the machine could be affected.

CE, UKCA, AS, EAC, CSA and ANSI A92.20 standards

Machine	HA16RTJ	
	SI	Imp.
Characteristics - Dimensions		
Maximum working height	16 m	52 ft 6 in
Maximum platform height	14 m	45 ft 11 in
Maximum horizontal reach	8,30 m	27 ft 3 in
Maximum outreach above the ground	7,80 m	25 ft 7 in
Maximum platform height before driving speed restriction	5,20 m	17 ft 5 in
Maximum boom articulation point height	7,60 m	24 ft 11 in
Platform rotation	165° (- 75° / + 90°)	
Jib working range	140° (- 80° / + 60°)	
Boom rotation angle	75°	
Turntable rotation	355°	
Total weight - Kubota Engine	6 055 kg	13,350 lbs
Total weight - Kubota Engine - Tires option 1025 x 365	6 600 kg	14,550 lbs
Total weight - Kubota Engine - With sand tires	6 490 kg	14,308 lbs
Total weight - Perkins Engine	6 095 kg	13,440 lbs
Total weight - Perkins Engine - Tires option 1025 x 365	6 640 kg	14,640 lbs
Maximum platform capacity	230 kg	500 lbs
Maximum number of occupants	2	
Maximum wind speed	45 km/h (12,5 m/s)	28 mph (41 ft/s)
Manual force	400 N - 90 lbf	
Gradeability - Forwards drive	40%	
Gradeability - Reverse drive	45%	
Gradeability - Reverse drive - With sand tires	30%	
Gradeability - Reverse drive - With sand tires	30%	

B - Familiarization

Machine	HA16RTJ	
Sideslope	25%	
Maximum rated slope allowed	5°	
Maximum load on wheel	3 265 kg	7,200 lbs
Maximum ground pressure of wheel on paved ground	13,4 kg/cm ²	27 500 lb/ft ²
Maximum ground pressure of wheel on paved ground - With sand tires	9,5 kg/cm ²	19 458 lb/ft ²
Drive speed:		
- Micro-speed	- 0,7 km/h	- 0.4 mph
- Slow speed	- 1,3 km/h	- 0.8 mph
- Medium speed	- 2,6 km/h	- 1.6 mph
- High speed	- 5,2 km/h	- 3.2 mph
Maximum freewheel speed during towed operation	5,2 km/h	3.2 mph
Specifications - Performance		
Operating temperature	From - 20°C to + 50°C (From - 4°F to + 122°F)	
Operating temperature For EAC only - If machine equipped with the option	From - 30°C to + 50°C (From - 22°F to + 122°F)	
Storage temperature	From - 40°C to + 70°C (From - 40°F to + 158°F)	
Energy storage		
Type of battery	Starter battery	
Cold cranking ampere	800 A - 1050 A	
Battery voltage	12 V	
Battery capacity	100 Ah - 110 Ah	
Hydraulic tank capacity	76 L	21 gal US
Fuel tank capacity	62 L	16 gal US
Propane bottles	30lb DOT LP gas cylinder	

B - Familiarization

CE, UKCA, AS, EAC, CSA and ANSI A92.20 standards

Machine	HA16RTJ O - HA46RTJ O	
Characteristics - Dimensions	SI	Imp.
Maximum working height	16 m	52 ft 6 in
Maximum platform height	14 m	45 ft 11 in
Maximum horizontal reach	8,30 m	27 ft 3 in
Maximum outreach above the ground	7,80 m	25 ft 7 in
Maximum platform height before driving speed restriction	5,20 m	17 ft 5 in
Maximum boom articulation point height	7,60 m	24 ft 11 in
Platform rotation	165° (- 75° / + 90°)	
Jib working range	140° (- 80° / + 60°)	
Boom rotation angle	75°	
Turntable rotation	355°	
Total weight - Kubota Engine	6 235 kg	13,750 lbs
Total weight - Kubota Engine - Tires option 1025 x 365	6 850 kg	15,100 lbs
Total weight - Kubota Engine - With sand tires	6 740 kg	14,860 lbs
Total weight - Perkins Engine	6 275 kg	13,835 lbs
Total weight - Perkins Engine - Tires option 1025 x 365	6 890 kg	15,190 lbs
Maximum platform capacity	230 kg	500 lbs
Maximum number of occupants	2	
Maximum wind speed	45 km/h (12,5 m/s)	28 mph (41 ft/s)
Manual force	400 N - 90 lbf	670 N - 150 lbf
Gradeability - Forwards drive	40%	
Gradeability - Reverse drive	45%	
Gradeability - Reverse drive - With sand tires	30%	
Gradeability - Reverse drive - With sand tires	30%	
Sideslope	25%	
Maximum rated slope allowed	5°	
Maximum load on wheel	3 330 kg (7,340 lbs)	3 020 kg (6,660 lbs)

B - Familiarization

Machine	HA16RTJ O - HA46RTJ O	
Maximum ground pressure of wheel on paved ground	13,7 kg/cm ² (28,100 lb/ft ²)	12,4 kg/cm ² (25,400 lb/ft ²)
Maximum ground pressure of wheel on paved ground - With sand tires	9,5 kg/cm ²	19 458 lb/ft ²
Drive speed:		
- Micro-speed	- 0,5 km/h	- 0.3 mph
- Slow speed	- 1,3 km/h	- 0.8 mph
- Medium speed	- 2,6 km/h	- 1.6 mph
- High speed	- 5,2 km/h	- 3.2 mph
Maximum freewheel speed during towed operation	5,2 km/h	3.2 mph

Specifications - Performance

Operating temperature	From - 20°C to + 50°C (From - 4°F to + 122°F)
Operating temperature For EAC only - If machine equipped with the option	From - 30°C to + 50°C (From - 22°F to + 122°F)
Storage temperature	From - 40°C to + 70°C (From - 40°F to + 158°F)

Energy storage

Type of battery	Starter battery	
Cold cranking ampere	800 A - 1050 A	
Battery voltage	12 V	
Battery capacity	100 Ah - 110 Ah	
Hydraulic tank capacity	76 L	21 gal US
Fuel tank capacity	62 L	16 gal US
Propane bottles	30lb DOT LP gas cylinder	

B - Familiarization**CE, UKCA, AS, EAC, CSA and ANSI A92.20 standards**

Machine	HA16RTJ PRO - HA46RTJ PRO	
	SI	Imp.
Characteristics - Dimensions		
Maximum working height	16 m	52 ft 6 in
Maximum platform height	14 m	45 ft 11 in
Maximum horizontal reach	8,30 m	27 ft 3 in
Maximum outreach above the ground	7,80 m	25 ft 7 in
Maximum platform height before driving speed restriction	5,20 m	17 ft 5 in
Maximum boom articulation point height	7,60 m	24 ft 11 in
Platform rotation	165° (- 75° / + 90°)	
Jib working range	140° (- 80° / + 60°)	
Boom rotation angle	75°	
Turntable rotation	360°Continuous	
Total weight - Kubota Engine	6 500 kg	14,330 lbs
Total weight - Kubota Engine - Tires option 1025 x 365	7 050 kg	15,540 lbs
Total weight - Kubota Engine - With sand tires	6 940 kg	15,300 lbs
Total weight - Perkins Engine	6 540 kg	14,420 lbs
Total weight - Perkins Engine - Tires option 1025 x 365	7 090 kg	15,630 lbs
Maximum platform capacity	230 kg	500 lbs
Maximum number of occupants	2	
Maximum wind speed	45 km/h (12,5 m/s)	28 mph (41 ft/s)
Manual force	400 N - 90 lbf	670 N - 150 lbf
Gradeability - Forwards drive	40%	
Gradeability - Reverse drive	45%	
Gradeability - Reverse drive - With sand tires	30%	
Gradeability - Reverse drive - With sand tires	30%	
Sideslope	25%	
Maximum rated slope allowed	5°	
Maximum load on wheel	3 330 kg (7,340 lbs)	3 020 kg (6,660 lbs)

B - Familiarization

Machine	HA16RTJ PRO - HA46RTJ PRO	
Maximum ground pressure of wheel on paved ground	13,7 kg/cm ² (28,100 lb/ft ²)	12,4 kg/cm ² (25,400 lb/ft ²)
Maximum ground pressure of wheel on paved ground - With sand tires	9,5 kg/cm ²	19 458 lb/ft ²
Drive speed:		
- Micro-speed	- 0,5 km/h	- 0.3 mph
- Slow speed	- 1,3 km/h	- 0.8 mph
- Medium speed	- 2,6 km/h	- 1.6 mph
- High speed	- 5,2 km/h	- 3.2 mph
Maximum freewheel speed during towed operation	5,2 km/h	3.2 mph

Specifications - Performance

Operating temperature	From - 20°C to + 50°C (From - 4°F to + 122°F)
Operating temperature For EAC only - If machine equipped with the option	From - 30°C to + 50°C (From - 22°F to + 122°F)
Storage temperature	From - 40°C to + 70°C (From - 40°F to + 158°F)

Energy storage

Type of battery	Starter battery	
Cold cranking ampere	800 A - 1050 A	
Battery voltage	12 V	
Battery capacity	100 Ah - 110 Ah	
Hydraulic tank capacity	76 L	21 gal US
Fuel tank capacity	62L	16 gal US
Propane bottles	30lb DOT LP gas cylinder	

B - Familiarization

4.2 Engine specifications

4.2.1 Kubota engines

Engine - Tier III	
Engine type	Kubota V1505 E2B
Engine power	26,5 kW - 35.54 hp
CO emission	1,14 g/kWh
HC + NO emission	5,065 g/kWh
Particles emission	0,311 g/kWh
Av fuel consumption	3 l/h - 0.79 gal/h
Fuel type	Diesel
Engine - Tier IV Final / Stage V / China IV	
Engine type	Kubota V1505
Engine power	18,5 kW - 24.8 hp
CO emission	1,4 g/kWh
HC + NO emission	5,8 g/kWh
Particles emission	0,21 g/kWh
Av fuel consumption	2,4 l/h - 0.63 gal/h
Fuel type	Diesel
Engine - Dual Fuel (Petrol / Propane Gas)	
Engine type	Kubota WG 1605 - GL - E03
Engine power	38 kW - 51 hp
CO emission	5,3 g/kWh
HC + NO emission	0,3 g/kWh
Av fuel consumption	Petrol: 3,6 l/h - 0.95 gal/h Gas: 4,3 l/h - 1.13 gal/h
Fuel type	Petrol/Propane Gas (liquified)

(1) Estimated consumption

B - Familiarization

For China only:

HA16 RTJ - HA16 RTJ O - HA16 RTJ PRO - Kubota Engine

环保信息标签		4001239740 b
达到 GB20891-2014 第四阶段排放标准		生产日期: <input type="text"/>
环保信息公开编号: <input type="text"/>		
基本信息	型号: <input type="text"/>	名称: 高空作业平台
	商标: 	机械类型: 工程机械
	■ 机械生产企业名称: 欧胜高空升降平台设备制造(常州)有限公司	
	■ 机械进口企业名称: 欧历胜贸易(上海)有限公司	
	发动机型号: <input type="text"/>	燃料喷射系统形式: 泵喷嘴
	发动机生产厂家名称: 久保田 机械编号: <input type="text"/>	
环保关键 ● 零部件	ECU, 喷油泵, 喷油器, 增压器, EGR, 排气后处理系统	

4.2.2 Perkins engines

Engine - Tier IV Final / Stage V	
Engine type	PERKINS 403J-17
Engine power	18,5 kW - 24.8 hp
CO emission	1,69 g/kWh
HC + NO emission	5,81 g/kWh
Particles emission	0,16 g/kWh
Av fuel consumption	2,1 l/h - 0.55 gal/h
Fuel type	Diesel

4.2.3 Kohler engines

Engine - Stage V	
Engine type	KOHLER KSD 1403 NA
Engine power	18,45 kW - 25 hp
CO emission	2,3 g/kWh
HC + NO emission	5,66 g/kWh
Particles emission	0,09 g/kWh
Av fuel consumption	2,2 l/h - 0,58 gal/h
Fuel type	Diesel Fuel Only

B - Familiarization

4.3 Working area / Range of motion

HA16RTJ - HA16RTJ O - HA16RTJ PRO - HA46RTJ O - HA46RTJ PRO

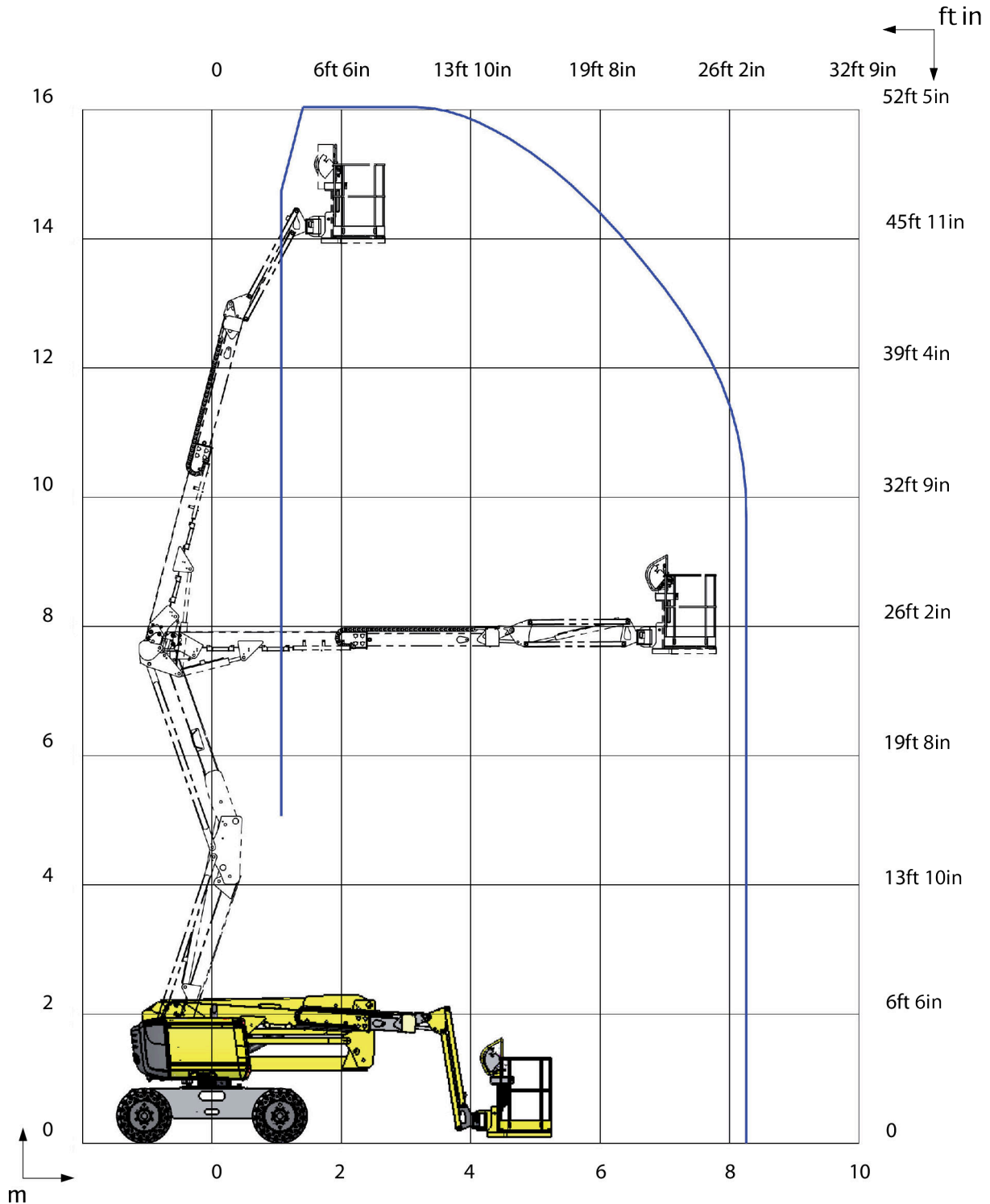

B - Familiarization

5 Decals and markings locations

CE, UKCA and AS standards

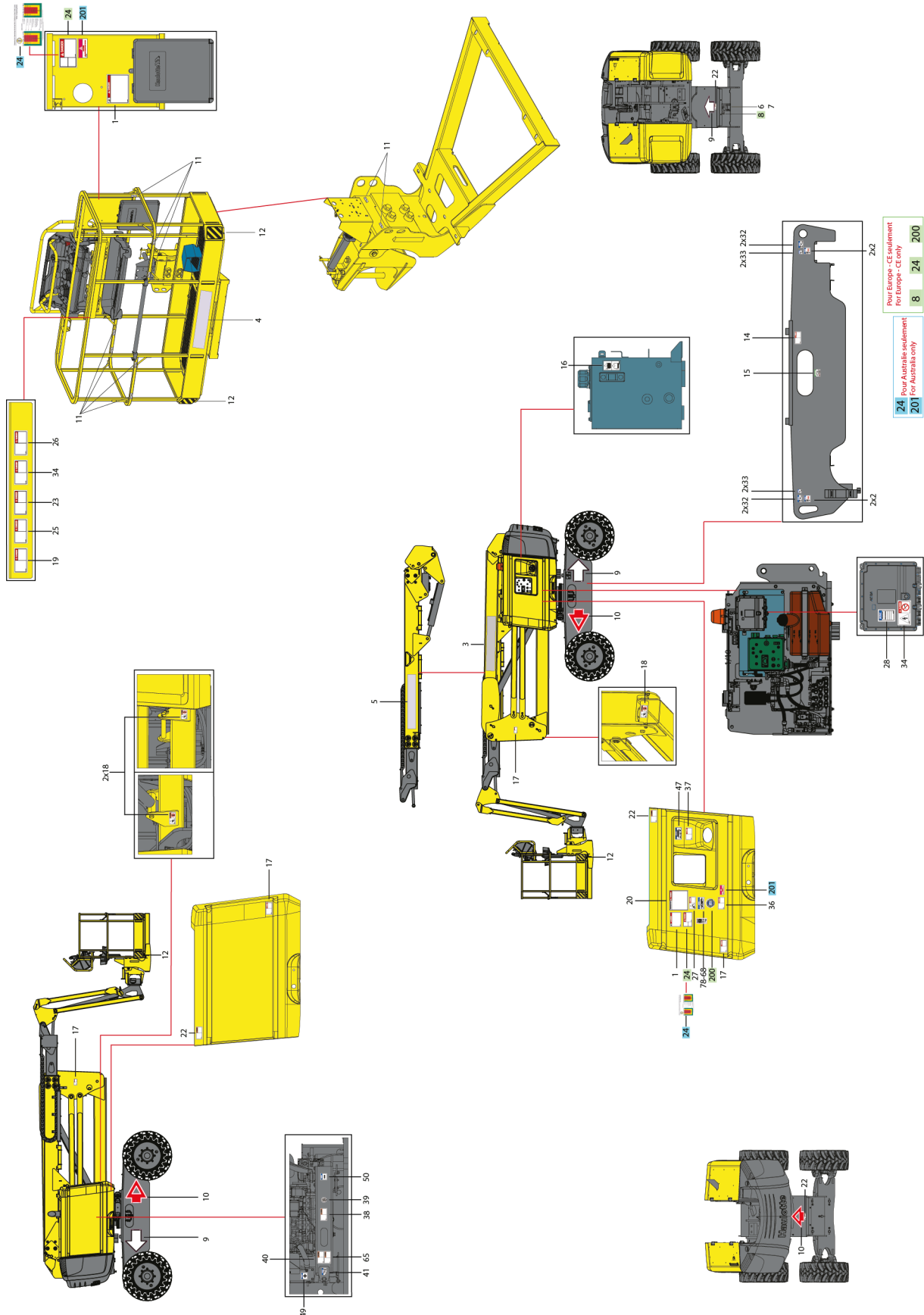

B - Familiarization**CE, UKCA and AS standards**

Marking	Color	Description	Quantity	HA16RTJ
1	Red	Height of the floor and load	2	4001097030
2	Blue	Maximum Pressure per Tire - Floor Loading - 830 x 285 wheel	4	4001231050
3	Other	Commercial name - Bright machine - Horizontal	1	4000138100
3	Other	Commercial name - Dark machine - Horizontal	1	4000138220
4	Other	Small format HAULOTTE® logo - Bright machine	1	307P217080
4	Other	Small format HAULOTTE® logo - Dark machine	1	307P220350
4	Other	Small format HAULOTTE® logo - Red machine	1	307P220360
5	Other	Large format HAULOTTE® logo - Bright machine	1	307P217230
5	Other	Large format HAULOTTE® logo - Dark machine	1	307P224930
5	Other	Large format HAULOTTE® logo - Red machine	1	307P224920
6	Other	Identification plates	1	4001243980
8	Other	Noise emission level	1	For CE, UKCA only: 3078148700
9	Other	Control of movements - WHITE directional arrow	3	4001319630
10	Other	Control of movements - RED directional arrow	3	4001319640
11	Other	Lanyard attachment points - Harness attachment compulsory	9	307P216290
12	Other	Material risk - Yellow and black adhesive tape	4	4000421700
14	Red	Risk of crushing - Spindle	1	4000027080
15	Other	Crown greasing	1	4000025160

B - Familiarization

Marking	Color	Description	Quantity	HA16RTJ
16	Other	Max and min oil level	1	307P221060
17	Red	Risk of crushing - Do not park	4	4000024800
18	Orange	Hand crushing hazard - Risk of crushed hands	3	4000024890
19	Other	Read the operation manual	1	4000025140
20	Red	Operation instructions	1	In german (CE and UKCA standards) : 307P222730
20	Red	Operation instructions	1	In english (CE, UKCA and AS standards) : 307P222740
20	Red	Operation instructions	1	In croatian (CE and UKCA standards) : 4000360810
20	Red	Operation instructions	1	In danish (CE and UKCA standards) : 307P222760
20	Red	Operation instructions	1	In spanish (CE and UKCA standards) : 307P222770
20	Red	Operation instructions	1	In estonian (CE and UKCA standards) : 4000360870
20	Red	Operation instructions	1	In finnish (CE and UKCA standards) : 307P222780
20	Red	Operation instructions	1	In french (CE and UKCA standards) : 3078149030
20	Red	Operation instructions	1	In dutch (CE and UKCA standards) : 307P222790
20	Red	Operation instructions	1	In hungarian (CE and UKCA standards) : 4000360890
20	Red	Operation instructions	1	In italian (CE and UKCA standards) : 307P222800
20	Red	Operation instructions	1	In japanese (CE and UKCA standards) : 4000359830
20	Red	Operation instructions	1	In latvian (CE and UKCA standards) : 4000359840
20	Red	Operation instructions	1	In lithuanian (CE and UKCA standards) : 4000359850
20	Red	Operation instructions	1	In norwegian (CE and UKCA standards) : 4000359900
20	Red	Operation instructions	1	In polish (CE and UKCA standards) : 4000359860

B - Familiarization

Marking	Color	Description	Quantity	HA16RTJ
20	Red	Operation instructions	1	In portuguese (CE and UKCA standards) : 307P222810
20	Red	Operation instructions	1	In romanian (CE and UKCA standards) : 4000359870
20	Red	Operation instructions	1	In slovakian (CE and UKCA standards) : 4000359880
20	Red	Operation instructions	1	In slovenian (CE and UKCA standards) : 4000359890
20	Red	Operation instructions	1	In swedish (CE and UKCA standards) : 307P222820
20	Red	Operation instructions	1	In greek (CE and UKCA standards) : 4000561810
22	Orange	Risk of crushing - Do not place foot	2	4000027090
23	Red	Risk of crushing - Driving direction	1	4000024690
24	Red	Danger of electrocution	2	For CE, UKCA only: 4000025070
24	Red	Danger of electrocution	2	For AS only: 4000227500
25	Red	Risk of crushing - Closing drop rail	1	4000025080
26	Red	Danger of electrocution - Ground for welding	1	4000027100
27	Other	Tilt verification	1	4000027110
28	Other	Do not interchange	1	4000504670
32	Blue	Towing anchorage point	4	4000027310
33	Blue	Lifting anchorage point	4	4000027330
34	Red	Electric Shock Hazards - Water projection	1	4000025130
36	Red	Risk of crushing - Emergency lowering	1	4000027460
37	Red	Risks of explosion	1	4000027370
38	Orange	Hand crushing hazard - Heat burns	1	4000027450
39	Other	Oil CJ 4 (if fitted)	1	4000019700
40	Orange	Hand crushing hazard - Snapping up	1	4000027430

B - Familiarization

Marking	Color	Description	Quantity	HA16RTJ
41	Blue	Revolving cradle	1	3078151730
47	Blue	Remplissage carburant - TIER IV	1	307P232480
49	Blue	Battery +	1	4000071960
50	Blue	Battery -	1	4000071970
68	Other	Transport height	1	4000417540
78	Other	QR Code - MyCompanion	1	4001281820
200	Other	Made in Europe	1	For CE, UKCA only: 4000137690
201	Red	Wearing of a safety harness is essential	1	AS standard only: 3078144520

B - Familiarization**CE, UKCA and AS standards**

Marking	Color	Description	Quantity	HA16RTJ O
1	Red	Height of the floor and load	2	4001097030
2	Blue	Maximum Pressure per Tire - Floor Loading - 830 x 285 wheel	4	4001231060
2	Blue	Maximum Pressure per Tire - Floor Loading - 1025 x 365 wheel	4	4000506600
3	Other	Commercial name - Bright machine- Horizontal	1	4000101940
3	Other	Commercial name - Dark machine - Horizontal	1	4000138200
4	Other	Small format HAULOTTE® logo - Bright machine	1	307P217080
4	Other	Small format HAULOTTE® logo - Dark machine	1	307P220350
4	Other	Small format HAULOTTE® logo - Red machine	1	307P220360
5	Other	Large format HAULOTTE® logo - Bright machine	1	307P217230
5	Other	Large format HAULOTTE® logo - Dark machine	1	307P224930
5	Other	Large format HAULOTTE® logo - Red machine	1	307P224920
6	Other	Identification plates	1	4001243980
8	Other	Noise emission level	1	For CE, UKCA only: 3078148700
9	Other	Control of movements - WHITE directional arrow	3	4001319630
10	Other	Control of movements - RED directional arrow	3	4001319640
11	Other	Lanyard attachment points - Harness attachment compulsory	9	307P216290
12	Other	Material risk - Yellow and black adhesive tape	4	4000421700

B - Familiarization

Marking	Color	Description	Quantity	HA16RTJ O
14	Red	Risk of crushing - Spindle	1	4000027080
15	Other	Crown greasing	1	4000025160
16	Other	Max and min oil level	1	307P221060
17	Red	Risk of crushing - Do not park	4	4000024800
18	Orange	Hand crushing hazard - Risk of crushed hands	3	4000024890
19	Other	Read the operation manual	1	4000025140
20	Red	Operation instructions	1	In german (CE and UKCA standards) : 307P222730
20	Red	Operation instructions	1	In english (CE, UKCA and AS standards) : 307P222740
20	Red	Operation instructions	1	In croatian (CE and UKCA standards) : 4000360810
20	Red	Operation instructions	1	In danish (CE and UKCA standards) : 307P222760
20	Red	Operation instructions	1	In spanish (CE and UKCA standards) : 307P222770
20	Red	Operation instructions	1	In estonian (CE and UKCA standards) : 4000360870
20	Red	Operation instructions	1	In finnish (CE and UKCA standards) : 307P222780
20	Red	Operation instructions	1	In french (CE and UKCA standards) : 3078149030
20	Red	Operation instructions	1	In dutch (CE and UKCA standards) : 307P222790
20	Red	Operation instructions	1	In hungarian (CE and UKCA standards) : 4000360890
20	Red	Operation instructions	1	In italian (CE and UKCA standards) : 307P222800
20	Red	Operation instructions	1	In japanese (CE and UKCA standards) : 4000359830
20	Red	Operation instructions	1	In latvian (CE and UKCA standards) : 4000359840
20	Red	Operation instructions	1	In lithuanian (CE and UKCA standards) : 4000359850
20	Red	Operation instructions	1	In norwegian (CE and UKCA standards) : 4000359900

B - Familiarization

Marking	Color	Description	Quantity	HA16RTJ O
20	Red	Operation instructions	1	In polish (CE and UKCA standards) : 4000359860
20	Red	Operation instructions	1	In portuguese (CE and UKCA standards) : 307P222810
20	Red	Operation instructions	1	In romanian (CE and UKCA standards) : 4000359870
20	Red	Operation instructions	1	In slovakian (CE and UKCA standards) : 4000359880
20	Red	Operation instructions	1	In slovenian (CE and UKCA standards) : 4000359890
20	Red	Operation instructions	1	In swedish (CE and UKCA standards) : 307P222820
20	Red	Operation instructions	1	In greek (CE and UKCA standards) : 4000561810
22	Orange	Risk of crushing - Do not place foot	2	4000027090
23	Red	Risk of crushing - Driving direction	1	4000024690
24	Red	Danger of electrocution	2	For CE, UKCA only: 4000025070
24	Red	Danger of electrocution	2	For AS only: 4000227500
25	Red	Risk of crushing - Closing drop rail	1	4000025080
26	Red	Danger of electrocution - Ground for welding	1	4000027100
27	Other	Tilt verification	1	4000027110
28	Other	Do not interchange	1	4000504670
32	Blue	Towing anchorage point	4	4000027310
33	Blue	Lifting anchorage point	4	4000027330
34	Red	Electric Shock Hazards - Water projection	1	4000025130
36	Red	Risk of crushing - Emergency lowering	1	4000027460
37	Red	Risks of explosion	1	4000027370
38	Orange	Hand crushing hazard - Heat burns	1	4000027450
39	Other	Oil CJ 4 (if fitted)	1	4000019700

B - Familiarization

Marking	Color	Description	Quantity	HA16RTJ O
40	Orange	Hand crushing hazard - Snapping up	1	4000027430
41	Blue	Revolving cradle	1	3078151730
47	Blue	Remplissage carburant - TIER IV	1	307P232480
49	Blue	Battery +	1	4000071960
50	Blue	Battery -	1	4000071970
68	Other	Transport height	1	4000417540
78	Other	QR Code - MyCompanion	1	4001281820
200	Other	Made in Europe	1	For CE, UKCA only: 4000137690
201	Red	Wearing of a safety harness is essential	1	AS standard only: 3078144520

B - Familiarization**CE, UKCA and AS standards**

Marking	Color	Description	Quantity	HA16RTJ PRO
1	Red	Height of the floor and load	2	4001097030
2	Blue	Maximum Pressure per Tire - Floor Loading - 830 x 285 wheel	4	4001231060
2	Blue	Maximum Pressure per Tire - Floor Loading - 1025 x 365 wheel	4	4000506600
3	Other	Commercial name - Bright machine - Horizontal	1	For CE, UKCA only: 4000138120
3	Other	Commercial name - Bright machine - Horizontal	1	For AS only: 4000101120
3	Other	Commercial name - Dark machine - Horizontal	1	4000138240
4	Other	Small format HAULOTTE® logo - Bright machine	1	307P217080
4	Other	Small format HAULOTTE® logo - Dark machine	1	307P220350
4	Other	Small format HAULOTTE® logo - Red machine	1	307P220360
5	Other	Large format HAULOTTE® logo - Bright machine	1	307P217230
5	Other	Large format HAULOTTE® logo - Dark machine	1	307P224930
5	Other	Large format HAULOTTE® logo - Red machine	1	307P224920
6	Other	Identification plates	1	4001243980
8	Other	Noise emission level	1	For CE, UKCA only: 3078148700
9	Other	Control of movements - WHITE directional arrow	3	4001319630
10	Other	Control of movements - RED directional arrow	3	4001319640
11	Other	Lanyard attachment points - Harness attachment compulsory	9	307P216290
12	Other	Material risk - Yellow and black adhesive tape	4	4000421700

B - Familiarization

Marking	Color	Description	Quantity	HA16RTJ PRO
14	Red	Risk of crushing - Spindle	1	4000027080
15	Other	Crown greasing	1	4000025160
16	Other	Max and min oil level	1	307P221060
17	Red	Risk of crushing - Do not park	4	4000024800
18	Orange	Hand crushing hazard - Risk of crushed hands	3	4000024890
19	Other	Read the operation manual	1	4000025140
20	Red	Operation instructions	1	In german (CE and UKCA standards) : 307P222730
20	Red	Operation instructions	1	In english (CE, UKCA and AS standards) : 307P222740
20	Red	Operation instructions	1	In croatian (CE and UKCA standards) : 4000360810
20	Red	Operation instructions	1	In danish (CE and UKCA standards) : 307P222760
20	Red	Operation instructions	1	In spanish (CE and UKCA standards) : 307P222770
20	Red	Operation instructions	1	In estonian (CE and UKCA standards) : 4000360870
20	Red	Operation instructions	1	In finnish (CE and UKCA standards) : 307P222780
20	Red	Operation instructions	1	In french (CE and UKCA standards) : 3078149030
20	Red	Operation instructions	1	In dutch (CE and UKCA standards) : 307P222790
20	Red	Operation instructions	1	In hungarian (CE and UKCA standards) : 4000360890
20	Red	Operation instructions	1	In italian (CE and UKCA standards) : 307P222800
20	Red	Operation instructions	1	In japanese (CE and UKCA standards) : 4000359830
20	Red	Operation instructions	1	In latvian (CE and UKCA standards) : 4000359840
20	Red	Operation instructions	1	In lithuanian (CE and UKCA standards) : 4000359850
20	Red	Operation instructions	1	In norwegian (CE and UKCA standards) : 4000359900

B - Familiarization

Marking	Color	Description	Quantity	HA16RTJ PRO
20	Red	Operation instructions	1	In polish (CE and UKCA standards) : 4000359860
20	Red	Operation instructions	1	In portuguese (CE and UKCA standards) : 307P222810
20	Red	Operation instructions	1	In romanian (CE and UKCA standards) : 4000359870
20	Red	Operation instructions	1	In slovakian (CE and UKCA standards) : 4000359880
20	Red	Operation instructions	1	In slovenian (CE and UKCA standards) : 4000359890
20	Red	Operation instructions	1	In swedish (CE and UKCA standards) : 307P222820
20	Red	Operation instructions	1	In greek (CE and UKCA standards) : 4000561810
22	Orange	Risk of crushing - Do not place foot	2	4000027090
23	Red	Risk of crushing - Driving direction	1	4000024690
24	Red	Danger of electrocution	2	For CE, UKCA only: 4000025070
24	Red	Danger of electrocution	2	For AS only: 4000227500
25	Red	Risk of crushing - Closing drop rail	1	4000025080
26	Red	Danger of electrocution - Ground for welding	1	4000027100
27	Other	Tilt verification	1	4000027110
28	Other	Do not interchange	1	4000504670
32	Blue	Towing anchorage point	4	4000027310
33	Blue	Lifting anchorage point	4	4000027330
34	Red	Electric Shock Hazards - Water projection	1	4000025130
36	Red	Risk of crushing - Emergency lowering	1	4000027460
37	Red	Risks of explosion	1	4000027370
38	Orange	Hand crushing hazard - Heat burns	1	4000027450
39	Other	Oil CJ 4 (if fitted)	1	4000019700

B - Familiarization

Marking	Color	Description	Quantity	HA16RTJ PRO
40	Orange	Hand crushing hazard - Snapping up	1	4000027430
41	Blue	Revolving cradle	1	3078151730
47	Blue	Remplissage carburant - TIER IV	1	307P232480
49	Blue	Battery +	1	4000071960
50	Blue	Battery -	1	4000071970
68	Other	Transport height	1	4000417540
78	Other	QR Code - MyCompanion	1	4001281820
200	Other	Made in Europe	1	For CE, UKCA only: 4000137690
201	Red	Wearing of a safety harness is essential	1	AS standard only: 3078144520

B - Familiarization

ANSI and CSA standards

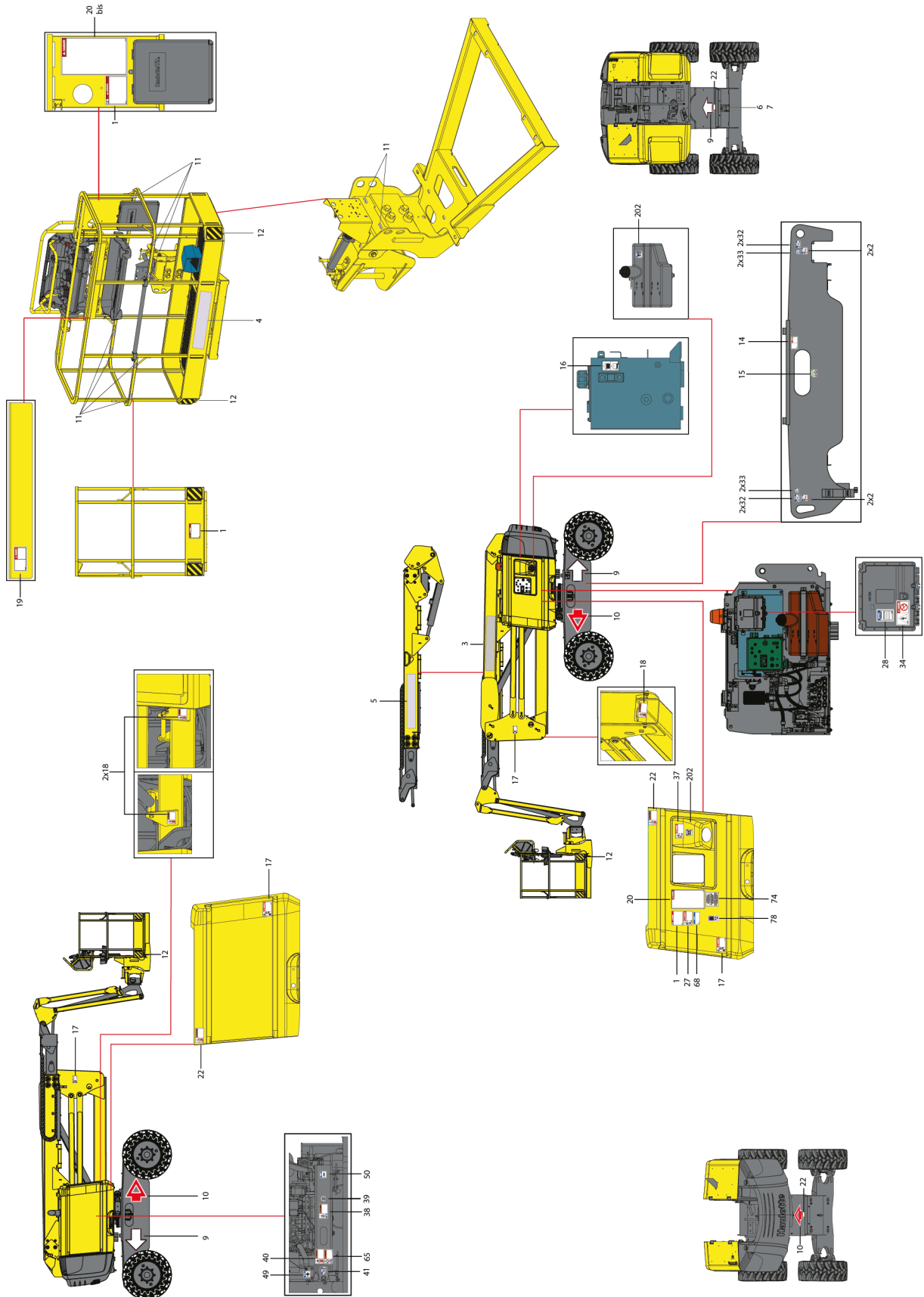

B - Familiarization

ANSI and CSA standards

Marking	Color	Description	Quantity	HA46RTJ
1	Red	Height of the floor and load	3	4001097030
2	Blue	Maximum Pressure per Tire - Floor Loading - 830 x 285 wheel	4	4001231050
3	Other	Commercial name - Bright machine - Horizontal	1	4000138160
3	Other	Commercial name - Dark machine - Horizontal	1	4000138280
4	Other	Small format HAULOTTE® logo - Bright machine	1	307P217080
4	Other	Small format HAULOTTE® logo - Dark machine	1	307P220350
4	Other	Small format HAULOTTE® logo - Red machine	1	307P220360
5	Other	Large format HAULOTTE® logo - Bright machine	1	307P217230
5	Other	Large format HAULOTTE® logo - Dark machine	1	307P224740
5	Other	Large format HAULOTTE® logo - Red machine	1	307P220360
6	Other	Identification plates	1	4000700170
9	Other	Control of movements - WHITE directional arrow	3	4001319630
10	Other	Control of movements - RED directional arrow	3	4001319640
11	Other	Lanyard attachment points - Harness attachment compulsory	9	307P216290
12	Other	Basket signalling	4	4000421700
14	Red	Risk of crushing - Spindle	1	In english: 4000024830
14	Red	Risk of crushing - Spindle	1	In french: 4000068080
14	Red	Risk of crushing - Spindle	1	In spanish: 4000086510
15	Other	Crown greasing	1	4000025160
16	Other	Max and min oil level	1	307P221060
17	Red	Risk of crushing - Do not park	4	In english: 4000024640
17	Red	Risk of crushing - Do not park	4	In french: 4000067680
17	Red	Risk of crushing - Do not park	4	In spanish: 4000086460
18	Orange	Hand crushing hazard - Risk of crushed hands	3	In english: 4000024770
18	Orange	Hand crushing hazard - Risk of crushed hands	3	In french: 4000067710
18	Orange	Hand crushing hazard - Risk of crushed hands	3	In spanish: 4000086490
19	Other	Read the operation manual	1	4000025140
20	Red	Operation instructions	1	In english: 4000027580

B - Familiarization

Marking	Color	Description	Quantity	HA46RTJ
20	Red	Operation instructions	1	In french: 4000083200
20	Red	Operation instructions	1	In spanish: 4000086650
20bis	Red	Operation instructions - Vertical	2	In english: 4000027570
20bis	Red	Operation instructions - Vertical	2	In french: 4000068880
20bis	Red	Operation instructions - Vertical	2	In spanish: 4000086640
22	Orange	Risk of crushing - Do not place foot	2	In english: 4000024840
22	Orange	Risk of crushing - Do not place foot	2	In french: 4000068180
22	Orange	Risk of crushing - Do not place foot	2	In spanish: 4000086610
27	Other	Tilt verification	1	In english: 4000024860
27	Other	Tilt verification	1	In french: 4000068090
27	Other	Tilt verification	1	In spanish: 4000086520
28	Other	Do not interchange	1	4000504670
32	Blue	Towing anchorage point	4	4000027310
33	Blue	Lifting anchorage point	4	4000027330
37	Red	Risks of explosion	1	In english: 4000025010
37	Red	Risks of explosion	1	In french: 4000068130
37	Red	Risks of explosion	1	In spanish: 4000086560
38	Orange	Hand crushing hazard - Heat burns	1	In english: 4000025040
38	Orange	Hand crushing hazard - Heat burns	1	In french: 4000068110
38	Orange	Hand crushing hazard - Heat burns	1	In spanish: 4000086540
39	Other	Oil CJ 4	1	4000019700
40	Orange	Hand crushing hazard - Snapping up	1	In english: 4000025020
40	Orange	Hand crushing hazard - Snapping up	1	In french: 4000068100
40	Orange	Hand crushing hazard - Snapping up	1	In spanish: 4000086530
41	Yellow	Revolving cradle	1	3078151730
47	Other	Remplissage carburant (only on Tier IV)		307P232480
49	Blue	Battery +	1	4000071960

B - Familiarization

Marking	Color	Description	Quantity	HA46RTJ
50	Blue	Battery -	1	4000071970
68	Other	Transport height	1	4000417540
74	Other	California warning - P65	1	4001026850
78	Other	QR Code - MyCompanion	1	4001281820
202	Other	Diesel Fuel Only	2	4000201430

B - Familiarization**ANSI and CSA standards**

Marking	Color	Description	Quantity	HA46RTJ O
1	Red	Height of the floor and load	3	4001097030
2	Blue	Maximum Pressure per Tire - Floor Loading - 830 x 285 wheel	4	4001231070
2	Blue	Maximum Pressure per Tire - Floor Loading - 1025 x 365 wheel	4	4000506600
3	Other	Commercial name - Bright machine - Horizontal	1	4000138140
3	Other	Commercial name - Dark machine - Horizontal	1	4000138260
4	Other	Small format HAULOTTE® logo - Bright machine	1	307P217080
4	Other	Small format HAULOTTE® logo - Dark machine	1	307P220350
4	Other	Small format HAULOTTE® logo - Red machine	1	307P220360
5	Other	Large format HAULOTTE® logo - Bright machine	1	307P217230
5	Other	Large format HAULOTTE® logo - Dark machine	1	307P224740
5	Other	Large format HAULOTTE® logo - Red machine	1	307P220360
6	Other	Identification plates	1	4000700170
9	Other	Control of movements - WHITE directional arrow	3	4001319630
10	Other	Control of movements - RED directional arrow	3	4001319640
11	Other	Lanyard attachment points - Harness attachment compulsory	9	307P216290
12	Other	Basket signalling	4	4000421700
14	Red	Risk of crushing - Spindle	1	In english: 4000024830
14	Red	Risk of crushing - Spindle	1	In french: 4000068080
14	Red	Risk of crushing - Spindle	1	In spanish: 4000086510
15	Other	Crown greasing	1	4000025160
16	Other	Max and min oil level	1	307P221060
17	Red	Risk of crushing - Do not park	4	In english: 4000024640
17	Red	Risk of crushing - Do not park	4	In french: 4000067680
17	Red	Risk of crushing - Do not park	4	In spanish: 4000086460
18	Orange	Hand crushing hazard - Risk of crushed hands	3	In english: 4000024770
18	Orange	Hand crushing hazard - Risk of crushed hands	3	In french: 4000067710
18	Orange	Hand crushing hazard - Risk of crushed hands	3	In spanish: 4000086490

B - Familiarization

Marking	Color	Description	Quantity	HA46RTJ O
19	Other	Read the operation manual	1	4000025140
20	Red	Operation instructions	1	In english: 4000027580
20	Red	Operation instructions	1	In french: 4000083200
20	Red	Operation instructions	1	In spanish: 4000086650
20bis	Red	Operation instructions - Vertical	2	In english: 4000027570
20bis	Red	Operation instructions - Vertical	2	In french: 4000068880
20bis	Red	Operation instructions - Vertical	2	In spanish: 4000086640
22	Orange	Risk of crushing - Do not place foot	2	In english: 4000024840
22	Orange	Risk of crushing - Do not place foot	2	In french: 4000068180
22	Orange	Risk of crushing - Do not place foot	2	In spanish: 4000086610
27	Other	Tilt verification	1	In english: 4000024860
27	Other	Tilt verification	1	In french: 4000068090
27	Other	Tilt verification	1	In spanish: 4000086520
28	Other	Do not interchange	1	4000504670
32	Blue	Towing anchorage point	4	4000027310
33	Blue	Lifting anchorage point	4	4000027330
37	Red	Risks of explosion	1	In english: 4000025010
37	Red	Risks of explosion	1	In french: 4000068130
37	Red	Risks of explosion	1	In spanish: 4000086560
38	Orange	Hand crushing hazard - Heat burns	1	In english: 4000025040
38	Orange	Hand crushing hazard - Heat burns	1	In french: 4000068110
38	Orange	Hand crushing hazard - Heat burns	1	In spanish: 4000086540
39	Other	Oil CJ 4	1	4000019700
40	Orange	Hand crushing hazard - Snapping up	1	In english: 4000025020
40	Orange	Hand crushing hazard - Snapping up	1	In french: 4000068100
40	Orange	Hand crushing hazard - Snapping up	1	In spanish: 4000086530
41	Yellow	Revolving cradle	1	3078151730
47	Other	Remplissage carburant (only on Tier IV)		307P232480
49	Blue	Battery +	1	4000071960

B - Familiarization

Marking	Color	Description	Quantity	HA46RTJ O
50	Blue	Battery -	1	4000071970
68	Other	Transport height	1	4000417540
74	Other	California warning - P65	1	4001026850
78	Other	QR Code - MyCompanion	1	4001281820
202	Other	Diesel Fuel Only	2	4000201430

B - Familiarization**ANSI and CSA standards**

Marking	Color	Description	Quantity	HA46RTJ PRO
1	Red	Height of the floor and load	3	4001097030
2	Blue	Maximum Pressure per Tire - Floor Loading - 830 x 285 wheel	4	4001231070
2	Blue	Maximum Pressure per Tire - Floor Loading - 1025 x 365 wheel	4	4000506600
3	Other	Commercial name - Bright machine - Horizontal	1	4000138180
3	Other	Commercial name - Dark machine - Horizontal	1	4000138300
4	Other	Small format HAULOTTE® logo - Bright machine	1	307P217080
4	Other	Small format HAULOTTE® logo - Dark machine	1	307P220350
4	Other	Small format HAULOTTE® logo - Red machine	1	307P220360
5	Other	Large format HAULOTTE® logo - Bright machine	1	307P217230
5	Other	Large format HAULOTTE® logo - Dark machine	1	307P224740
5	Other	Large format HAULOTTE® logo - Red machine	1	307P220360
6	Other	Identification plates	1	4000700170
9	Other	Control of movements - WHITE directional arrow	3	4001319630
10	Other	Control of movements - RED directional arrow	3	4001319640
11	Other	Lanyard attachment points - Harness attachment compulsory	9	307P216290
12	Other	Basket signalling	4	4000421700
14	Red	Risk of crushing - Spindle	1	In english: 4000024830
14	Red	Risk of crushing - Spindle	1	In french: 4000068080
14	Red	Risk of crushing - Spindle	1	In spanish: 4000086510
15	Other	Crown greasing	1	4000025160
16	Other	Max and min oil level	1	307P221060
17	Red	Risk of crushing - Do not park	4	In english: 4000024640
17	Red	Risk of crushing - Do not park	4	In french: 4000067680
17	Red	Risk of crushing - Do not park	4	In spanish: 4000086460
18	Orange	Hand crushing hazard - Risk of crushed hands	3	In english: 4000024770
18	Orange	Hand crushing hazard - Risk of crushed hands	3	In french: 4000067710
18	Orange	Hand crushing hazard - Risk of crushed hands	3	In spanish: 4000086490

B - Familiarization

Marking	Color	Description	Quantity	HA46RTJ PRO
19	Other	Read the operation manual	1	4000025140
20	Red	Operation instructions	1	In english: 4000027580
20	Red	Operation instructions	1	In french: 4000083200
20	Red	Operation instructions	1	In spanish: 4000086650
20bis	Red	Operation instructions - Vertical	2	In english: 4000027570
20bis	Red	Operation instructions - Vertical	2	In french: 4000068880
20bis	Red	Operation instructions - Vertical	2	In spanish: 4000086640
22	Orange	Risk of crushing - Do not place foot	2	In english: 4000024840
22	Orange	Risk of crushing - Do not place foot	2	In french: 4000068180
22	Orange	Risk of crushing - Do not place foot	2	In spanish: 4000086610
27	Other	Tilt verification	1	In english: 4000024860
27	Other	Tilt verification	1	In french: 4000068090
27	Other	Tilt verification	1	In spanish: 4000086520
28	Other	Do not interchange	1	4000504670
32	Blue	Towing anchorage point	4	4000027310
33	Blue	Lifting anchorage point	4	4000027330
37	Red	Risks of explosion	1	In english: 4000025010
37	Red	Risks of explosion	1	In french: 4000068130
37	Red	Risks of explosion	1	In spanish: 4000086560
38	Orange	Hand crushing hazard - Heat burns	1	In english: 4000025040
38	Orange	Hand crushing hazard - Heat burns	1	In french: 4000068110
38	Orange	Hand crushing hazard - Heat burns	1	In spanish: 4000086540
39	Other	Oil CJ 4	1	4000019700
40	Orange	Hand crushing hazard - Snapping up	1	In english: 4000025020
40	Orange	Hand crushing hazard - Snapping up	1	In french: 4000068100
40	Orange	Hand crushing hazard - Snapping up	1	In spanish: 4000086530
41	Yellow	Revolving cradle	1	3078151730
47	Other	Remplissage carburant (only on Tier IV)		307P232480
49	Blue	Battery +	1	4000071960

B - Familiarization

Marking	Color	Description	Quantity	HA46RTJ PRO
50	Blue	Battery -	1	4000071970
68	Other	Transport height	1	4000417540
74	Other	California warning - P65	1	4001026850
78	Other	QR Code - MyCompanion	1	4001281820
202	Other	Diesel Fuel Only	2	4000201430

B - Familiarization**EAC standard**

Marking	Color	Description	Quantity	HA16RTJ
1	Red	Height of the floor and load	2	4000270060
2	Blue	Maximum Pressure per Tire - Floor Loading - 830 x 285 wheel	4	4001231050
3	Other	Commercial name - Bright machine - Horizontal	1	4000138100
3	Other	Commercial name - Dark machine - Horizontal	1	4000138220
6	Other	Identification plates	1	For Russia: 4000278870
6	Other	Identification plates	1	For Ukraine: 307P227830
8	Other	Noise emission level	1	3078148700
9	Other	Control of movements - WHITE directional arrow	3	4001319630
10	Other	Control of movements - RED directional arrow	3	4001319640
11	Other	Lanyard attachment points - Harness attachment compulsory	9	307P226710
12	Other	Material risk - Yellow and black adhesive tape	4	4000421700
14	Red	Risk of crushing - Spindle	1	307P227810
15	Other	Crown greasing	1	307P227020
16	Other	Max and min oil level	1	307P221060
18	Orange	Hand crushing hazard - Risk of crushed hands	3	307P227660
19	Other	Read the operation manual	1	For Russia: 307P227190
19	Other	Read the operation manual	1	For Ukraine: 307P227840
20	Red	Operation instructions	1	For Russia: 4000359920
20	Red	Operation instructions	1	For Ukraine: 4000359910
22	Orange	Risk of crushing - Do not place foot	2	307P227010
23	Red	Risk of crushing - Driving direction	1	307P227040
24	Red	Danger of electrocution	2	307P226960
25	Red	Risk of crushing - Closing drop rail	1	307P226950
26	Red	Danger of electrocution - Ground for welding	1	307P226970

B - Familiarization

Marking	Color	Description	Quantity	HA16RTJ
27	Other	Tilt verification	1	For Russia: 307P227060
27	Other	Tilt verification	1	For Ukraine: 307P227870
28	Other	Do not interchange	1	4000504670
32	Blue	Towing anchorage point	4	4000135970
33	Blue	Lifting anchorage point	4	4000135960
34	Red	Electric Shock Hazards - Water projection	1	307P226780
36	Red	Risk of crushing - Emergency lowering	1	4000014290
38	Orange	Hand crushing hazard - Heat burns	1	4000200810
39	Other	Oil CJ 4	1	4000318680
40	Orange	Hand crushing hazard - Snapping up	1	307P226940
41	Yellow	Revolving cradle	1	307P215290
47	Other	Remplissage carburant (only on Tier IV)		For Russia: 4000416640
47	Other	Remplissage carburant (only on Tier IV)		For Ukraine: 4000416650
49	Blue	Battery +	1	4000071960
50	Blue	Battery -	1	4000071970
68	Other	Transport height	4	4000417540
78	Other	QR Code - MyCompanion	1	4001281820
204	Other	Lubrication point	12	307P219370
206	Other	Flames prohibited	2	307P226750
207	Other	Smoking forbidden	1	307P226760
209	Other	Battery danger	1	307P226790
210	Other	Fire Hazard	1	307P226800
211	Other	Electrical danger	1	307P226810
213	Other	Corrosion hazard	1	307P226830
214	Other	Danger unstable sideH41	1	307P226930
216	Other	Tamper-proof		For Russia: - For HA16RTJ: 307P227450 x 8.
216	Other	Tamper-proof		For Ukraine: - For HA16RTJ: 307P227453 x 8.
217	Blue	Caution glasses	1	307P227460

B - Familiarization

Marking	Color	Description	Quantity	HA16RTJ
218	Other	Caution helmet compulsory	1	307P226680
220	Blue	Hand protection compulsory	1	307P227490
221	Other	Obligatory routing	1	307P227510
222	Yellow	Danger unstable side	1	307P227680
223	Other	Plug 12 V	1	307P227700
225	Other	Cold weather oil	1	307P223700
229	Other	Do not travel down slopes in high speed	1	307P226990
230	Other	No admittance	1	307P227560
236	Other	Caution glasses	1	307P226670
237	Yellow	Lateral crushing of the body	4	307P227670

B - Familiarization**EAC standard**

Marking	Color	Description	Quantity	HA16RTJ O
1	Red	Height of the floor and load	2	4000270060
2	Blue	Maximum Pressure per Tire - Floor Loading - 830 x 285 wheel	4	4001231060
2	Blue	Maximum Pressure per Tire - Floor Loading - 1025 x 365 wheel	4	4000506600
3	Other	Commercial name - Bright machine - Horizontal	1	4000101940
3	Other	Commercial name - Dark machine - Horizontal	1	4000138200
6	Other	Identification plates	1	For Russia: 4000278870
6	Other	Identification plates	1	For Ukraine: 307P227830
8	Other	Noise emission level	1	3078148700
9	Other	Control of movements - WHITE directional arrow	3	4001319630
10	Other	Control of movements - RED directional arrow	3	4001319640
11	Other	Lanyard attachment points - Harness attachment compulsory	9	307P226710
12	Other	Material risk - Yellow and black adhesive tape	4	4000421700
14	Red	Risk of crushing - Spindle	1	307P227810
15	Other	Crown greasing	1	307P227020
16	Other	Max and min oil level	1	307P221060
18	Orange	Hand crushing hazard - Risk of crushed hands	3	307P227660
19	Other	Read the operation manual	1	For Russia: 307P227190
19	Other	Read the operation manual	1	For Ukraine: 307P227840
20	Red	Operation instructions	1	For Russia: 4000359920
20	Red	Operation instructions	1	For Ukraine: 4000359910
22	Orange	Risk of crushing - Do not place foot	2	307P227010
23	Red	Risk of crushing - Driving direction	1	307P227040
24	Red	Danger of electrocution	2	307P226960
25	Red	Risk of crushing - Closing drop rail	1	307P226950

B - Familiarization

Marking	Color	Description	Quantity	HA16RTJ O
26	Red	Danger of electrocution - Ground for welding	1	307P226970
27	Other	Tilt verification	1	For Russia: 307P227060
27	Other	Tilt verification	1	For Ukraine: 307P227870
28	Other	Do not interchange	1	4000504670
32	Blue	Towing anchorage point	4	4000135970
33	Blue	Lifting anchorage point	4	4000135960
34	Red	Electric Shock Hazards - Water projection	1	307P226780
36	Red	Risk of crushing - Emergency lowering	1	4000014290
38	Orange	Hand crushing hazard - Heat burns	1	4000200810
39	Other	Oil CJ 4	1	4000318680
40	Orange	Hand crushing hazard - Snapping up	1	307P226940
41	Yellow	Revolving cradle	1	307P215290
47	Other	Remplissage carburant (only on Tier IV)		For Russia: 4000416640
47	Other	Remplissage carburant (only on Tier IV)		For Ukraine: 4000416650
49	Blue	Battery +	1	4000071960
50	Blue	Battery -	1	4000071970
68	Other	Transport height	4	4000417540
78	Other	QR Code - MyCompanion	1	4001281820
204	Other	Lubrication point	12	307P219370
206	Other	Flames prohibited	2	307P226750
207	Other	Smoking forbidden	1	307P226760
209	Other	Battery danger	1	307P226790
210	Other	Fire Hazard	1	307P226800
211	Other	Electrical danger	1	307P226810
213	Other	Corrosion hazard	1	307P226830
214	Other	Danger unstable sideH41	1	307P226930
216	Other	Tamper-proof		For Russia: - For HA16RTJO: 307P227451 x 10

B - Familiarization

Marking	Color	Description	Quantity	HA16RTJ O
216	Other	Tamper-proof		For Ukraine: - For HA16RTJO: 307P227454 x 10
217	Blue	Caution glasses	1	307P227460
218	Other	Caution helmet compulsory	1	307P226680
220	Blue	Hand protection compulsory	1	307P227490
221	Other	Obligatory routing	1	307P227510
222	Yellow	Danger unstable side	1	307P227680
223	Other	Plug 12 V	1	307P227700
225	Other	Cold weather oil	1	307P223700
229	Other	Do not travel down slopes in high speed	1	307P226990
230	Other	No admittance	1	307P227560
236	Other	Caution glasses	1	307P226670
237	Yellow	Lateral crushing of the body	4	307P227670

B - Familiarization**EAC standard**

Marking	Color	Description	Quantity	HA16RTJ PRO
1	Red	Height of the floor and load	2	4000270060
2	Blue	Maximum Pressure per Tire - Floor Loading - 830 x 285 wheel	4	4001231060
2	Blue	Maximum Pressure per Tire - Floor Loading - 1025 x 365 wheel	4	4000506600
3	Other	Commercial name - Bright machine - Horizontal	1	4000101120
3	Other	Commercial name - Dark machine - Horizontal	1	4000138240
6	Other	Identification plates	1	For Russia: 4000278870
6	Other	Identification plates	1	For Ukraine: 307P227830
8	Other	Noise emission level	1	3078148700
9	Other	Control of movements - WHITE directional arrow	3	4001319630
10	Other	Control of movements - RED directional arrow	3	4001319640
11	Other	Lanyard attachment points - Harness attachment compulsory	9	307P226710
12	Other	Material risk - Yellow and black adhesive tape	4	4000421700
14	Red	Risk of crushing - Spindle	1	307P227810
15	Other	Crown greasing	1	307P227020
16	Other	Max and min oil level	1	307P221060
18	Orange	Hand crushing hazard - Risk of crushed hands	3	307P227660
19	Other	Read the operation manual	1	For Russia: 307P227190
19	Other	Read the operation manual	1	For Ukraine: 307P227840
20	Red	Operation instructions	1	For Russia: 4000359920
20	Red	Operation instructions	1	For Ukraine: 4000359910
22	Orange	Risk of crushing- Do not place foot	2	307P227010
23	Red	Risk of crushing - Driving direction	1	307P227040
24	Red	Danger of electrocution	2	307P226960
25	Red	Risk of crushing - Closing drop rail	1	307P226950

B - Familiarization

Marking	Color	Description	Quantity	HA16RTJ PRO
26	Red	Danger of electrocution - Ground for welding	1	307P226970
27	Other	Tilt verification	1	For Russia: 307P227060
27	Other	Tilt verification	1	For Ukraine: 307P227870
28	Other	Do not interchange	1	4000504670
32	Blue	Towing anchorage point	4	4000135970
33	Blue	Lifting anchorage point	4	4000135960
34	Red	Electric Shock Hazards - Water projection	1	307P226780
36	Red	Risk of crushing - Emergency lowering	1	4000014290
38	Orange	Hand crushing hazard - Heat burns	1	4000200810
39	Other	Oil CJ 4	1	4000318680
40	Orange	Hand crushing hazard - Snapping up	1	307P226940
41	Yellow	Revolving cradle	1	307P215290
47	Other	Remplissage carburant (only on Tier IV)		For Russia: 4000416640
47	Other	Remplissage carburant (only on Tier IV)		For Ukraine: 4000416650
49	Blue	Battery +	1	4000071960
50	Blue	Battery -	1	4000071970
68	Other	Transport height	4	4000417540
78	Other	QR Code - MyCompanion	1	4001281820
204	Other	Lubrication point	12	307P219370
206	Other	Flames prohibited	2	307P226750
207	Other	Smoking forbidden	1	307P226760
209	Other	Battery danger	1	307P226790
210	Other	Fire Hazard	1	307P226800
211	Other	Electrical danger	1	307P226810
213	Other	Corrosion hazard	1	307P226830
214	Other	Danger unstable sideH41	1	307P226930

B - Familiarization

Marking	Color	Description	Quantity	HA16RTJ PRO
216	Other	Tamper-proof		For Russia: - For HA16RTJPRO: 307P227452 x 10
216	Other	Tamper-proof		For Ukraine: - For HA16RTJPRO: 307P227455 x 10
217	Blue	Caution glasses	1	307P227460
218	Other	Caution helmet compulsory	1	307P226680
220	Blue	Hand protection compulsory	1	307P227490
221	Other	Obligatory routing	1	307P227510
222	Yellow	Danger unstable side	1	307P227680
223	Other	Plug 12 V	1	307P227700
225	Other	Cold weather oil	1	307P223700
229	Other	Do not travel down slopes in high speed	1	307P226990
230	Other	No admittance	1	307P227560
236	Other	Caution glasses	1	307P226670
237	Yellow	Lateral crushing of the body	4	307P227670

C - Pre-operation inspection

1	Recommendations.....	3
2	Working area assessment.....	4
3	Inspection and Functional test.....	5
3.1	Daily inspection.....	5
4	Safety functional checks.....	10
4.1	Emergency Stop button check.....	10
4.2	Activation of controls.....	11
4.3	Fault detector.....	11
4.4	Automatic engine cut-out.....	12
4.5	Overload sensing system.....	12
4.6	Oscillating axles (If equipped)	12
4.7	Slope warning device.....	12
4.8	Travel speed limitation.....	14
4.9	On-board electronics.....	14
4.10	Braking test.....	15
4.11	Overload test.....	15

C - Pre-operation inspection

1 Recommendations

The owner, the site manager, the supervisor and the operator are all responsible to ensure the machine is fit for the work it is to perform; i.e. that the machine is suitable to carry out the work in complete safety and in compliance with this Operator's Manual. All managers who are responsible for persons operating the machine must be familiar with the local regulations currently applicable in the country of use and ensure that they are adhered to.

Before using the machine, read the previous chapters in this manual. Ensure that you have understood the following points:

- Safety precautions.
- Operator's responsibilities.
- Conditions and the operating principles of the machine.

C - Pre-operation inspection

2 Working area assessment

Before carrying out any operations, ensure that the machine corresponds to the work to be done and the working environment:

- Carry out a thorough inspection of the site to identify any potential risks within the work zone.
- Take the necessary precautions to avoid collisions with other machinery or people within the work area.
- Mark out the work area.
- **Ensure that:**
 - The weather conditions (wind, rain, etc.) allowing the machine to be used.
 - The ground withstands the weight of the machine and has not been affected by the poor weather conditions.
- Check that the authorisations to work with the machine on the site in question have been obtained (.g. chemical product factories).
- Define a rescue plan for all the risks, including the risk of falls and crushing.

C - Pre-operation inspection

3 Inspection and Functional test

3.1 Daily inspection

Each day before the beginning of a new work session and with each change of operator, the machine must be subjected to a visual inspection and a complete functional test.



- Never use a defective or a malfunctioning aerial work platform.
- If any item on the check list is marked "No" during the inspection; machine must be tagged and placed out of service.
- Do not operate the machine until all identified items are corrected and it has been declared safe for operation.

In case of loose fasteners, refer to torque table value in maintenance book.

In case of leaks, replace the damaged part before use.

In case of structural part deformation (cracks, broken weld, paint chips) replace the part before use.



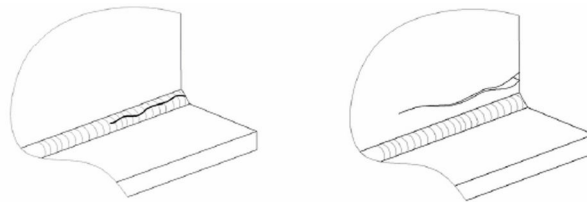





Examples of cracked welds



We recommend these forms to be completed daily and stored to assist with your maintenance schedule.

Each action is depicted in the daily inspection sheet using the following symbols.











Use the detailed program below.

	Oil change		Lubrication-Lubrication		Tightening
	Levelling		Systematic replacement		Functional adjustments / Checks / Cleaning
	Visual inspection		To check by test		





Serial number: Hours of operation: HAULOTTE Services® contract reference: Intervention record number: Date: Name:	Model: Signature:
--	----------------------

C - Pre-operation inspection

Articulated and telescopic fuel-powered aerial work platforms













	Daily	OK	NOK	Corrected	Comments
Chassis assembly: Wheel, reducer, steering, wheel pivot					
Check state of tires/tyres and inflations					
Thermal engines					
Check engine fuel level (Top up the oil if necessary)					
Check engine oil level (Top up the oil if necessary)					
No leaks from engine components (engine, hoses, radiator)					
Check the condition of the battery					
Check the cooling circuit level (Top up the oil if necessary)					
Check the condition of the circuit LPG (If equipped)					
Check the operation of the lock on the engine casing					
Turntable					
Test the operation of the turntable locking system					
Hydraulic : oils, filters and hoses					
Check the hydraulic oil level (Top up the oil if necessary ; Machine stowed)					

C - Pre-operation inspection







Haulotte 	Daily	OK	NOK	Corrected	Comments
Check the clogging indicator on the hydraulic pressure filter (change if clogged)					
Check the hoses, blocks and pumps, fittings, cylinders and the tank for the absence of leaks, deformations and damage					
Platform					
Ensure that the gate or sliding bar shall be designed to either return automatically to the closed and latched position					
Check that the harness anchor points are not cracked or damaged					

C - Pre-operation inspection

Articulated and telescopic fuel-powered aerial work platforms

	Daily	OK	NOK	Corrected	Comments
General					
Check for the presence, cleanliness and readability of the manufacturer's plates, security labels, user manual and maintenance manual					
Check the cleanliness and readability of the control box					
Test the opening and closure of covers (chassis, turntable, upper control box)					
Check the condition of electrical harnesses, cables and connectors					
Check for the absence of abnormal noise and jerky movements					
Check for the absence of visible deterioration and damage					
Check for the absence of cracks, broken welds and chipped paintwork on the structure					
Check for the absence of missing or loose screws and bolts					
Check for the absence of deformation, cracking and breakage of axis stops, bushing and axes					
Check for the absence of foreign bodies in joints and sliding parts					
Safety devices					
Test the operation of the upper and lower control boxes: manipulators, switches, buttons, horn, emergency stops, screens and lights					
Test the operation of visual and audible alarms					

C - Pre-operation inspection

	Daily	OK	NOK	Corrected	Comments
Test the operation of the tilt system					
Test the operation of the emergency lowering system					
Test the operation of the axle locking system					
Check the operation of the overload indicator					
Test the operation of the Activ Shield Bar (If equipped)					

C - Pre-operation inspection

4 Safety functional checks

To protect the user and the machine, safety systems prevent the movement of the machine beyond its operating limits. These safety systems when activated immobilize the machine and prevent further movement.

The operator must be familiar with this technology and understand that is not a malfunction but an indication that the machine has reached an operation limit.

The aerial work platforms are fitted with a platform control box (main control box) and a ground control box (emergency control box) enabling users to use the machine safely. An auxiliary system (Overriding system) is available on the ground control box in order to rescue anyone trapped on the platform.

The following checks describe the operation of the machine and the specific controls required.



For the location and description of these controls: refer to section B 3.2 and D 2 - Ground control box and B 3.3 and D 3 - Platform control box.

4.1 Emergency Stop button check

Ground control box Emergency Stop button

Step	Action
1	Pull the Emergency Stop button (9) at the ground control box.
2	Set the key switch (22) at ground box to the  position
3	The indicator (10) lights up on ground control box
4	Start the engine by pressing the engine start-up selector (16) .
5	Push in the Emergency Stop button (9).
6	Check that the engine stops running.
7	Check no movements are functional.

Platform control box Emergency Stop button

Step	Action
1	Pull both Emergency Stop buttons (9) at ground box and (46) at platform box.
2	Set the key switch (22) at ground box to the  position
3	The indicator (13) lights up on ground display panel
4	Start the engine from platform using Start/Stop switch (230).
5	Push in Emergency Stop button (46) at platform.
6	Check that the engine stops running.
7	Check no movements are functional.

C - Pre-operation inspection

4.2 Activation of controls

The enable foot pedal (enable switch) must be activated to allow any movement.

The "Enable Switch" system depends on the machine configuration and will consist of one of the following:

- Enable switch at ground box (6).
- Foot pedal (enable switch) in the platform (C42).

N.B.:-THE ENABLE SWITCH MUST BE ACTIVATED FIRST BEFORE ANY ACTION ON THE JOYSTICK OR SWITCHES.

4.3 Fault detector

The machine is equipped with an on-board fault detection system, which indicates the type of fault to the operator.

The fault is identified by a default code.

The default code is displayed at the ground control box.

According to the type of fault, the machine MAY switch into DOWNGRADEMODE mode and certain movements are prevented to maintain Operator's safety.

Do not use the machine until the fault has been corrected.

4.3.1 Indicators/LED's test

From the ground control box

Step	Action
1	Pull the Emergency Stop button (46) at the platform control box.
2	Set the key switch (22) at ground box to the  position.
3	Check that indicators (10, 13, 15, 19) flash upon start-up and ACTIV'SCREEN is lit.

From the platform control box

Step	Action
1	Pull Emergency Stop button (9) at ground box.
2	Set the key switch (22) at ground box to the  position.
3	First push in the Emergency Stop button (46) at platform box, then pull out.
4	Check that the indicators (101 - 117) on the platform control box flash upon start-up.

C - Pre-operation inspection

4.3.2 Buzzers test

From the ground control box

Step	Action
1	Pull both Emergency Stop buttons (9) at ground box and (46) at platform box.
2	Set the key switch (22) at ground box to the  position.
3	The buzzers on the ground and platform beep upon start-up.

4.4 Automatic engine cut-out

The engine automatically cuts out in the following conditions:

- The machine has been inactive for 90 s.
- The alternator is not functioning.
- Engine temperature is too high.
- Oil pressure is too low.
- The Emergency Stop(s) is (are) pushed in.
- The machine is switched off.

4.5 Overload sensing system

If the platform load exceeds the maximum allowed load, no movement is possible from the 2 control boxes.

At ground and platform control boxes a buzzer sounds and an indicator light warns the operator.

To return the machine to normal operation remove weight from the platform until the load is below the maximum allowed load.

Daily check that the LED's illuminate when the machine is switched on:

- Verify that the Overload system is active: Refer to Indicator (15) at ground control box and LED (114) at platform control box display.
- Verify that the buzzers are functioning: Refer to  Buzzers test.

A periodic inspection of this device must be performed according to the recommendation in  Maintenance Schedule.

4.6 Oscillating axles (If equipped)

To improve the driving capability on rough terrain, the front axle is equipped with an oscillating mechanism. When the extending structure is retracted and is in the stowed position, oscillating mechanism is unlocked to adapt itself to the features of ground operation. When the extending structure is out of the stowed position, a safety device locks the oscillating mechanism to reduce overturning hazard.

A visual inspection must be performed to ensure the absence of leaks from the oscillating cylinder and associated plumbing connections including the hydraulic hoses.

A periodic inspection of this device must be conducted according to the recommendation in the maintenance schedule.

4.7 Slope warning device

From each control box, a buzzer alerts the operator that the machine is not folded/stowed and is positioned on a slope exceeding the slope allowed.

N.B.-:THE SLOPE SENSOR IS ONLY ACTIVE WHEN THE PLATFORM IS NOT IN THE STOWED POSITION.

When machine is on a slope greater than the rated slope, with extending structure out of the stowed position, DRIVE function is disabled.

C - Pre-operation inspection

All the lifting movements are cut. Only the lowering movements are authorized.

In this case, fully lower the platform and reposition the machine on level ground before raising the platform again.

To restore DRIVE function, perform the following steps before repositioning on level ground:

Machine on slope with the platform uphill





Step	Action
1	Retract the boom.
2	Lower the bottom arm.
3	Lower the upper boom

Machine on slope with the platform downhill

Step	Action
1	Lower the upper boom.
2	Lower the top arm.
3	Retract the boom.

C - Pre-operation inspection

To check the tilt sensor at ground level

Step	Action
1	Open the right hand compartment cover (Component location diagrams) and locate the tilt sensor (C28).
2	Pull both Emergency Stop buttons; (9) at ground box and (46) at platform box.
3	Set the key switch (22) at ground box to the  position.
4	Start the engine by pressing the engine start-up selector (16) START / STOP.
5	To stow the machine: <ul style="list-style-type: none"> - Retract the boom using the command (3) by pressing and holding the  button . - Lower the boom using the boom raising (4) by pressing and holding the  button . - Lower the arm using the arm raising (5) by pressing and holding the  button .
6	Raise the boom to more than 10 degrees above horizontal using the control boom raising (4) by pressing and holding the  button .
7	Raise the boom to more than 10 degrees above horizontal using the raise/lower switch (10).
8	While manually tilting the sensor (C28), move it towards the front and hold.
9	Check that the audible beep sounds.

4.8 Travel speed limitation

The machine has a selector of 3 driving speeds - low, medium and high.

All driving speeds are authorised when extending structure of the machine is in stowed position (transport configuration). Drive speed is proportional to the movement of the drive joystick (33). Adjust position of Jib to enhance field of vision during driving.

Whatever the position of the drive speed selector switch (45) on the platform control box, the drive speed is limited when the machine is unfolded.

Daily check that the speed is limited to less than 1 km/h (0.6 mph) when:

- The boom is raised by more than 10° above horizontal.
- The boom is telescoped/extended more than 400 mm (16 in).
- The arm is raised by more than 2 m (6 ft 7 in) above horizontal.

4.9 On-board electronics

The machine is equipped with a specific calculator configured for this machine's functionalities.

C - Pre-operation inspection

Do not interchange calculators between machines, as this may result in the loss of parameters, settings, calibrations, and render the machine inoperable.

4.10 Braking test



Check that there are no hazards in the test area:

- Position the machine on a flat and firm surface, clear of obstructions (beware of power lines).
- The machine must be completely stowed.
- Ensure that there is sufficient distance to stop the machine in complete safety.
- Position the steered wheels so that they are straight.
- To set up a beaconing of safety around the test area.
- Personal fall protection equipment (PFPE) is compulsory to carry out this test.

Platform control box

Step	Action
1	Pull both Emergency Stop buttons; at ground box and at platform box.
2	Turn the ground control box selector key to platform control box position.
3	Select low drive speed , then slowly move the drive joystick.
4	Drive the machine forward in low speed on a ramp inclined at less than the maximum authorized slope.
5	Release joystick.
6	The machine comes to a complete stop. Keep the machine immobilized for 5 seconds.
7	Check the ability of the brakes to keep the machine immobilized. The machine must remain immobile.

4.11 Overload test





N.B.-:-

THE OVERLOAD SYSTEM IS AN ESSENTIAL PART OF MACHINE SAFETY. THE TEST MUST BE CARRIED OUT BEFORE THE SALE/RESALE OF THE MACHINE AND/OR AT LEAST ONCE A YEAR.



SECTION MAINTENANCE - PLEASE REFER TO PARAGRAPH PERIODIC INSPECTION.

You will need:

 <ul style="list-style-type: none"> - Personal protective equipment - DO NOT OPERATE tag - Standard tool kit - Lifting equipment adapted and suitable for placing and removing the load from the platform - 2 loads of 100% and 120% of the nominal load: Refer to section B  - Technical specifications. 	 <ul style="list-style-type: none"> - Place barriers around the perimeter of the work area
 <p>1 person</p>	

C - Pre-operation inspection

Procedure:

Platform control box

Step	Action
1	Position the machine on a flat and firm surface, clear of obstructions (beware of power lines).
2	Start the machine.
3	Put the machine in stowed position.
4	Mark out the work area (barriers, cones, marking tape) .
5	Restrict access to the area (restricted access sign).
6	Place a do not operate tag at the start/stop switch location to inform personnel that the equipment is being worked on.
7	Use external lifting equipment to position 100% of the nominal load in the center of the platform.
8	From the ground control box: Check that there is no overload alarm.
9	Remove the weight from the platform.
10	Use external lifting equipment to position 120% of the nominal load in the center of the platform.
11	Check that the overload/fault indicators are lighted on the 2 control boxes.
12	Check that the overload alarms are displayed on the screens of the 2 control boxes.
13	Remove the load from the platform.

D - Operation instructions

1	Operation.....	3
1.1	Introduction.....	3
1.2	Major description.....	3
1.3	Operation from the ground control box (Service / Emergency station)	3
1.4	Operation from the platform control box (Main station)	4
2	Ground control box - Service / Emergency station.....	6
2.1	To start and stop the machine-Diesel engine.....	6
2.2	To start and stop the machine - Petrol / gas (Propane) Engine.....	6
2.3	Movement control.....	6
2.4	Additional controls.....	8
3	Platform control box - Main station.....	9
3.1	To start and stop the machine.....	9
3.2	To start and stop the machine - Petrol / gas (Propane) Engine.....	9
3.3	Drive and steer control.....	10
3.4	Movement control.....	10
3.5	Additional controls.....	12
4	Rescue and emergency procedures.....	13
4.1	In case of power loss.....	13
4.2	To rescue operator in platform.....	14
4.3	Operation of overriding system from ground control box.....	14
4.4	No power available.....	14
5	Transportation.....	15
5.1	Transport configuration.....	15
5.2	Machine stowage for transport - HA16RTJ - HA16RTJO - HA16RTJ PRO - HA46RTJO - HA46RTJ PRO.....	16
5.3	Unloading.....	17
5.4	Towing.....	17
5.5	Storage.....	18
5.6	Lifting operation.....	19
6	Cold Weather Recommendations.....	21
6.1	Engine oil.....	21
6.2	Hydraulic oil.....	22
6.3	Preheating operation.....	22

D - Operation instructions

1 Operation

1.1 Introduction

Only trained and authorized personnel shall be permitted to operate this aerial work platform.

Prior to operation:

- Read, understand and obey all instructions and safety precautions in this manual and attached to the aerial work platform.
- Read, understand and obey all local regulations.
- Become familiar with the proper use of all controls and emergency systems.

1.2 Major description

All the machines are equipped with:

- Platform control box.
- Ground control box.



- An Emergency Stop button is present at each control box.
- The Emergency Stop button at the ground control box stops all movements when pressed in.
- The Emergency Stop button at the platform control box stops all movements when pressed in and the platform control box is selected. The Emergency Stop button at the platform control box is neutralized when the ground control box is selected.

1.3 Operation from the ground control box (Service / Emergency station)

The ground control box is designed for maintenance and emergency rescue operations only.

- Turning "ON" and "OFF" of the machine is performed with the Control box activation key switch (22).
- Activation of a desired control box is achieved by turning the Control box activation key switch (22) to



the desired position .

- The ground control box is energized and is active ONLY when:
 - The emergency stop on the ground control box is not pushed in.
 - The machine is switched on.
 - Ground control box is selected.

N.B.-:DO NOT TURN OFF THE POWER SUPPLY OF THE MACHINE USING THE EMERGENCY STOP BUTTON (USE ONLY IN CASE OF EMERGENCY) . TURN OFF THE POWER SUPPLY OF THE MACHINE USING THE CONTROL BOX





ACTIVATION KEY SWITCH (22) TO POSITION.

- An Enable Switch (6) provided must be activated and maintained to authorize one or more function movements. If Enable Switch (6) is kept engaged without selecting a function movement for more than 8s; Enable Switch is automatically de-activated.

N.B.-:THE ENABLE SWITCH (6) MUST BE ACTIVATED FIRST BEFORE ANY ACTION ON THE JOYSTICK OR SWITCHES.

- Drive and steer movements are not possible from the ground control box.
- All controls and joystick operating a movement, return automatically to neutral when released.
- At power up, all controls must be in their neutral position (not activated).
- Enable Switch / Back-up unit selector (6):
 - With engine running, the control switch functions as an Enable Switch only.
 - With engine stopped, the control function as the Enable Switch and allows the back-up unit (emergency pump) functioning.
- Overriding system: Refer to  D 4.2 - To rescue operator in platform.

D - Operation instructions

- The status of the controls is tested automatically when the machine is switched on. A control will be active only after it has been detected to be in neutral position. The flashing light control (14) is not controlled.
- A control (16) provides the start and stop of the engine.
- A buzzer beeps in the following conditions:
 - When power is switched on.
 - Overload.
 - Slope if machine is out of stowed position.
 - Hydraulic oil overheating.
 - Movement buzzer option.
 - Drive buzzer option.
- Indicators: Indicators (10), (13), (15) and (19) are checked when the machine is powered on
- For petrol / gas machines:
 - For desired type of fuel; activate button (18)  for petrol or (17)  for propane gas

1.4 Operation from the platform control box (Main station)

- The platform control box is energized only when:
 - The Emergency Stop buttons on both ground and platform control boxes are not pressed in.
 - To switch ON the machine, turn the Control box activation key selector (22) at the ground control box  on ground control box position.
- A faulty joystick is not taken into account to control a movement. If this fault disappears, the movement is authorised again.

N.B.-:DO NOT TURN OFF THE POWER SUPPLY OF THE MACHINE USING THE EMERGENCY STOP BUTTON (USE ONLY IN CASE OF EMERGENCY) . TURN OFF THE POWER SUPPLY OF THE MACHINE USING THE CONTROL BOX

ACTIVATION KEY SWITCH (22) TO  POSITION.

- A Foot Switch (C42) is present that should be activated and maintained to authorize one or more movements. If Foot Switch is kept engaged without selecting a function movement for more than 8 s seconds ; Enable switch is automatically de-activated.

N.B.-:THE ENABLE SWITCH (C42) MUST BE ACTIVATED FIRST BEFORE ANY ACTION ON THE JOYSTICK OR SWITCHES.

- The release of foot pedal switch while performing a movement, stops that function movement and all other movements are inactive. The stop of movements is progressive. If the Foot Switch is pressed again quickly within 0,5 s the movement restarts. If the Foot Switch and / or Enable Switch is not pressed again quickly enough within + 0,5 s the movement will not restart. It could restart only when the selected function switch/joystick is released to neutral position.
- All switches and joystick operating a movement, return automatically to neutral when released.
- Pressing the Foot Switch (C42) restarts the machine when its engine has been stopped by the Stop Emission System after 90 s of inactivity.
- At power up, all switches and joysticks must be in their neutral position.
- For the US destined machines:
 - The fuel selection (petrol or liquid propane gas) is done by turning the switch (44) to the desired position.
- The status of the switches is tested automatically when the machine is switched on and checked at every starting. A switch will be activated only after it has been detected in neutral position.
- A buzzer beeps in the following conditions:
 - When power is switched on.
 - Overload.
 - Slope if machine is out of stowed position.

D - Operation instructions

- Hydraulic oil overheating.
 - Movement buzzer option.
 - Drive buzzer option.
- Emergency pump. ( D 4.1 - In case of engine power failure).
 - Indicators: All indicators (LEDs 101 - 117) are checked when the machine is powered on.



While driving on a slope:

- While driving, always place the boom above the rear axle, in the direction of movement.
- Always orientate the machine in the direction of the slope.
- Always place the boom in fully retracted and in stowed position.
- Do not travel down slopes in high speed.
- Do not drive fast in narrow or cluttered areas. Keep speed under control while making turns or sharp bends.

D - Operation instructions

2 Ground control box - Service / Emergency station

2.1 To start and stop the machine-Diesel engine

- Check that the Emergency Stop buttons (9) at ground control box and (46) at platform control box are not pressed in.



- Turn the control box selector (22) to position  to energize the ground control box. The LED display panel comes on.
- Push the starter selector (16) upwards. The engine starts. The indicators go out.
- Let the engine heat up.

To shut-down the machine from the ground control box

- Push the starter selector (16) upwards. The engine stops.



- Turn the key activation selector switch (22) in position .
- The machine is now switched off.

N.B.-:THIS OPERATION TURNS THE MACHINE OFF AND IT IS REQUIRED TO PREVENT BATTERY DISCHARGE.

N.B.-:THE ACTIV'SCREEN AUTOMATICALLY GOES INTO STANDBY IF IT IS NOT USED FOR AN EXTENDED PERIOD. TO SWITCH THE ACTIV'SCREEN BACK ON, TURN THE KEY SELECTOR TO POSITION OFF THEN FOLLOW THE START-UP PROCEDURE.

2.2 To start and stop the machine - Petrol / gas (Propane) Engine

- Open the gas bottle valve (C140).
- At the ground control box, check that the Emergency Stop button (9) is not pressed in.



- Turn the control box selector (22) to position  to energize the ground control box.
- Press the propane gas control (17) for liquid gasoline supply.
- Press the starter selector (16) to start the engine.
- Let the engine heat up.

To shut-down the machine from the ground control box:

- Press the starter selector (16) to stop the engine.



- Turn the activation selector key switch (22) to off position .
- Power supply is now switched off.
- Close the gas bottle valve (C140).

N.B.-:THIS OPERATION TURNS OFF THE POWER SUPPLY TO MACHINE AND IT IS REQUIRED TO PREVENT BATTERY DISCHARGE.



If the gas bottle is empty, the engine stops. Press switch (18) for gasoline supply. Restart the engine.

N.B.-:THE ACTIV'SCREEN AUTOMATICALLY GOES INTO STANDBY IF IT IS NOT USED FOR AN EXTENDED PERIOD. TO SWITCH THE ACTIV'SCREEN BACK ON, TURN THE KEY SELECTOR TO POSITION OFF THEN FOLLOW THE START-UP PROCEDURE.







2.3 Movement control

N.B.-:THE ENABLE SWITCH (6) MUST BE ACTIVATED FIRST BEFORE ANY ACTION ON THE JOYSTICK OR SWITCHES.

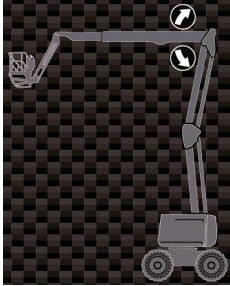

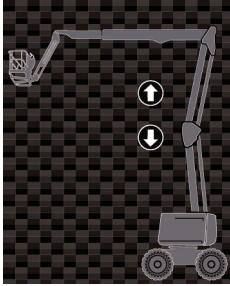

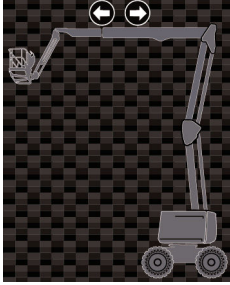

N.B.-:RELEASING THE ENABLE SWITCH (6) WILL STOP ALL MOVEMENTS.

D - Operation instructions

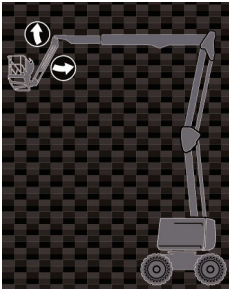
Ground box controls (emergency station)

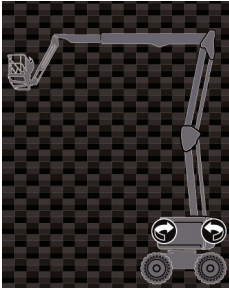
Command		Action
Raising / lowering of boom		Press the boom raising control (4) to raise  the boom.
		Press the boom lowering control (4) to lower  the boom.
Raising / lowering of arm		Press the arm raising control (5) upwards  to raise the arm
		Press the arm lowering control (5) downwards  to lower the arm
Boom telescoping extend / retract		Press the boom telescoping control (3) to extend  the boom.
		Press the boom retracting control (3) to retract  the boom.

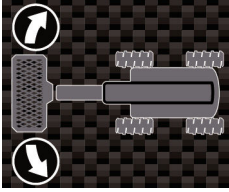
D - Operation instructions

Command	Action	
Jib raising / lowering (If applicable)		Press the jib raising control (2) to raise  the jib.
		Press the jib lowering control (2) to lower  the jib.
Turntable rotation		Press the turntable rotation control (7) for a clockwise rotation  .
		Press the turntable rotation control (7) for an counterclockwise rotation  .
Platform rotation		Press the platform rotation control (8) for a clockwise rotation  .
		Press the platform rotation control (8) for an counterclockwise rotation  .

2.4 Additional controls

- Press the beacon light control (14)  to turn ON or OFF be beacon light.
- Push the horn selector (12) to the right to sound the horn. The horn stops when the selector switch is released.

D - Operation instructions

3 Platform control box - Main station

3.1 To start and stop the machine

3.1.1 To start the machine

At the ground control box

- Check that the Emergency Stop button (9) is not pressed in.



- Turn the control box activation key switch (22) to platform position  to energize platform control box.

At the platform control box

- Check that the Emergency Stop button (46) on platform control box is not pressed in.
- Push the starter selector switch (230) upwards. During pre-heating, the indicator (102) comes ON on the display panel of the platform control box. Pre-heating begins and the engine starts.
- Allow the engine to heat up and initialize.

3.1.2 To stop the engine

- Press the engine starter selector (230) and the engine stops.

3.1.3 If engine is stopped by Stop Emission System

- The Stop Emission System automatically stops the engine after 90 s of inactivity.
- Press the foot switch (C42) to restart the engine.

N.B.-:IF THE FOOT SWITCH IS STILL ENGAGED, RELEASE AND PRESS AGAIN.



The Activ'Screen automatically goes into standby if it is not used for an extended period. To switch the Activ'Screen back on, press and release the emergency stop button then follow the start-up procedure.

3.2 To start and stop the machine - Petrol / gas (Propane) Engine

To start the machine:

At the ground control box:

- Open the gas bottle valve.
- Check that the Emergency Stop button (9) is not pressed in.

- Turn the control box key selector (22) on position  to energize the machine and activate the platform control box

At the platform control box:

- Open the gas bottle valve.
- Check that the Emergency Stop button (46) is not pressed in.
- Turn the petrol/liquid propane gas selector (44) into LPG position
- Push the starter selector switch (230) upwards. During pre-heating LED (102) at platform display panel and LED (5) at ground display panel will light up. Pre-heating begins and the engine starts.
- Allow the engine to heat up and initialize.

To stop the engine:

- Push engine start switch (230) upwards.

D - Operation instructions

- Close the gas bottle valve



If the gas bottle is empty, the engine stops. Turn the petrol/liquid propane gas selector (44) into G position. Restart the engine.



The Activ'Screen automatically goes into standby if it is not used for an extended period. To switch the Activ'Screen back on, press the emergency stop button then follow the start-up procedure.

3.3 Drive and steer control







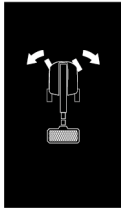

To activate drive and steer function, press the Foot Switch and simultaneously operate the joystick (33) for the desired function.

N.B.-:THE ENABLE SWITCH (C42) MUST BE ACTIVATED FIRST BEFORE ANY ACTION ON THE JOYSTICK OR SWITCHES.

Before moving, locate the white and red directional arrows on the chassis and the platform control box.

Move the drive control joystick (33) in the direction matching the directional arrows.

N.B.-:ON UNEVEN TERRAIN, LOWER THE BOOM TO IMPROVE THE DRIVE PERFORMANCE.

Command		Action
Steering		Press thumb/rocker switch on joystick (33) to the right to steer right.
		Press thumb/rocker switch on joystick (33) to the left to steer left.
Driving		Move joystick (33) forwards for the machine to travel in the forward direction.
		Pull joystick (33) backwards for the machine to travel in the reverse direction.
Drive speed		Position the drive speed selector switch (45) on  for high-speed driving.
		Position the driving speed selector (45) on  for medium speed driving (crossing uneven ground, slope).
		Set the speed selector to (45)  for low speed movements (short distance, final approach, drift and when crossing a slope).

3.4 Movement control

Activate the desired control and the Foot Switch simultaneously to perform that selected function.

N.B.-:THE ENABLE SWITCH (C42) MUST BE ACTIVATED FIRST BEFORE ANY ACTION ON THE JOYSTICK OR SWITCHES.



D - Operation instructions

Foot Switch

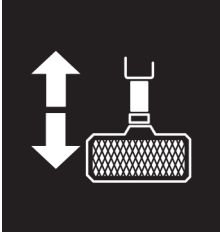
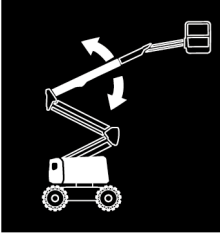
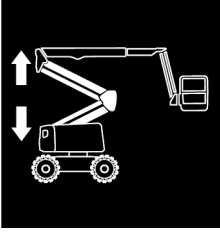
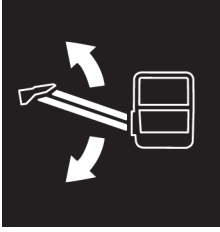

Command	Action	
Boom telescoping extend / retract		Push the boom telescoping switch (54) upwards to retract the boom.
		Push the boom telescoping switch (54) downwards to extend the boom.
Boom raising / lowering		Move the boom/turntable joystick (49) forward to raise the boom.
		Move the boom/turntable joystick (49) backwards to lower the boom.
Arm raising / lowering		Push the arm joystick (50) forwards to raise the arm.
		Push the arm joystick (50) backwards to lower the arm.
Jib raising / lowering		Push the jib switch (129) upwards to raise the jib.
		Push the jib switch (129) downwards to lower the jib.

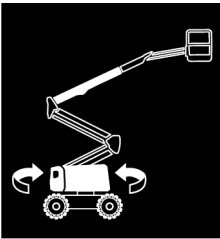
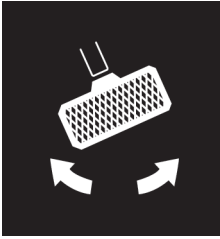
D - Operation instructions

Command		Action
Turntable rotation		Move the boom/turntable joystick (49) to the left for a clockwise (CW) rotation.
		Move the boom/turntable joystick (49) to the right for a counter clockwise (CCW) rotation.
Platform rotation		Move the platform rotation switch (38) to the right for a counter clockwise (CCW) rotation.
		Move the platform rotation switch (38) to the left for a clockwise (CW) rotation.
Platform leveling		Move the platform levelling switch (40) upwards to raise the platform to the front of the machine.
		Move the platform levelling switch (40) downwards to tilt the platform to the rear of the machine.

3.5 Additional controls

- Horn: Push the horn selector (43) to the right to sound the horn. The horn stops when the selector switch is released.

3.5.1 Stop Emission System

The machine is equipped with the innovative Stop Emission System that automatically stops the engine after 90 s of inactivity. Engine can be restarted by pressing the 'enable switch' foot pedal (C42).

N.B.-:THIS SYSTEM IS ONLY AVAILABLE WHEN THE PLATFORM CONTROL BOX IS SELECTED.



If the machine is equipped with arctic option, Stop Emission System is deactivated. The Stop Emission System can be reactivated at any time by a HAULOTTE Services® technician.

3.5.2 Activ' Lighting System

Refer to  B 3.3 - Platform control box.

This option means that the operator will be able to safely load (or unload) the machine onto the truck.

Located on the turntable, boom and platform, the Activ' Lighting System system lights up the controls and surrounding areas of the machine. Users can then safely move the machine.

D - Operation instructions

4 Rescue and emergency procedures

4.1 In case of power loss

Should the main power source fail, the secondary emergency power supply, powered by the starter battery, enables movements to be controlled both from the ground control box (on the ground) or from the platform control box (in the platform).

As the electric pump has limited power, it is advisable to reach the ground in the most direct manner possible.

The use of the electric pump is exclusively reserved for lowering the boom in emergency situations only. You are advised to retract the telescope before lowering the boom.

N.B.-:TEST THE OPERATION OF EMERGENCY SYSTEM ATLEAST ONCE A MONTH. REFER TO THE SERVICE MANUAL.

Depending on the control box in use, push and hold the back-up/auxiliary power switch (6) at ground box or switch (41) at platform box. Retract the boom and lower it by using controls (3), (4) and (4) at ground control box or switch (54) and joystick (49) at platform control box.

In an emergency, if the operator has to exit the platform while it is elevated, the transfer of the operator must respect the following recommendations.

- Exit onto a sturdy and safe structure.
- Allowance must be made for the possibility of boom deflection when egressing from the platform.
- The occupant(s) must ensure that the 2 harness straps provided are used, for safety. One must be attached to the designated anchorage point on platform the occupant(s) is in and the other attached to the structure intended to get on.
- Do not leave the platform without taking into account the possibility that the machine might move when removing the load.
- Occupant(s) must exit the current platform through the normal access.

N.B.-:DO NOT DETACH THE LANYARD FROM THE CURRENT PLATFORM IF THE TRANSFER TO THE NEW STRUCTURE POSES ANY DANGER OR UNTIL THE TRANSFER IS SAFELY COMPLETED. DO NOT ATTEMPT TO CLIMB DOWN THE BOOM. INSTEAD WAIT FOR ASSISTANCE FOR A SAFE EXIT.

D - Operation instructions

4.2 To rescue operator in platform



In a situation where an operator located in the platform needs to be rescued (for example in case of illness, injury or trapped against a structure making the control box inaccessible), the rescue personnel at ground level needs to obtain rapid and direct access to operating functions.

HAULOTTE® has implemented a control system for safely lowering the operator to the ground in the event of an emergency to enable him to receive the necessary treatment.



The system allows occupant(s) to be lowered to the ground level, even if an Emergency Stop is engaged or if an overload is detected.

Procedure:

- Turn the ground control box key control (22) to the ground control box  position.
- The platform box controls are now de-energized.
- Check that the Emergency Stop button (9) at ground is not pressed in.
- To lower the platform, hold down the Enable Switch (6)  and simultaneously activate the desired control function.







4.3 Operation of overriding system from ground control box

N.B.:-IF THE SAFETY SYSTEMS DO NOT ALLOW NORMAL MOVEMENT FROM THE GROUND CONTROL BOX, OR IN THE EVENT OF OVERHEATING, USE THE OVERRIDING SYSTEM DESCRIBED BELOW.



Operation of the "overriding system" switch must be an exception and not a normal emergency operation.

Procedure

- Press and hold the "overriding" system control (11) .
- Press simultaneously the telescoping boom control (3) to retract the boom .
- Press the boom raising control (4) to raise  or lower  the boom.
- Press the arm raising control (5) to raise  or lower  the arm.

N.B.:-ONCE RESCUE OPERATIONS ARE COMPLETE, WRITE AN INCIDENT REPORT.

4.4 No power available

In case of loss of the main power and the secondary power unit not functioning, do not attempt to activate any function movement using hydraulic manifold unless trained and authorized by HAULOTTE Services®. All safety functions are no longer active and several hazards may occur. Improper use of the equipment will result in death or serious injuries.



If the operator cannot be lowered by any of the above mentioned methods, contact HAULOTTE Services® immediately.

D - Operation instructions

5 Transportation

5.1 Transport configuration



During loading, ensure that:

- The loading ramp can support the machine weight.
- The loading ramp is correctly attached to transport vehicle.
- The loading ramp has sufficient grip surface.
- The transport vehicle must be parked on a level surface and must be secured to prevent rolling away while machine is being loaded or unloaded.
- The floor of the transport truck and/or the trailer can bear the weight of the machine.



Do not place yourself below or too close to the machine during loading.

The machine must be completely in the stowed configuration:

- Check the platform is completely empty.

To climb the slope, select low driving speed.

If the slope is too steep, use a winch in addition to the low speed drive.

- Ensure that the jib is raised as necessary to give ground clearance when driving the machine onto the loading ramp.
- Drive onto the truck bed slowly. While constantly checking the wheel position.
- Secure the machine to the tie down points provided ( Section D - Machine layout) .
- Lock the turntable with the rotation stop pin located under the turntable before transporting ( Section D - Machine layout) .
- The platform/basket must be chocked and the boom strapped to prevent bouncing up and down, thus preventing possible material damage during transporting.
- Do not use excessive downward force when securing boom section.



A wrong move can lead to machine tipping over and may cause serious injuries and material damage.



Always align the boom in the axis of the machine and climb slopes with the platform lowered and on the downhill side of the machine.



To enter or exit from the platform: Falling Hazards ( A 2.1.2) .



Risk of overturning: Ensure the stability and strength of the trailer or transport platform before performing turret rotation.

D - Operation instructions

5.2 Machine stowage for transport - HA16RTJ - HA16RTJO - HA16RTJ PRO - HA46RTJO - HA46RTJ PRO

Turntable rotation enabled



Turntable rotation disabled

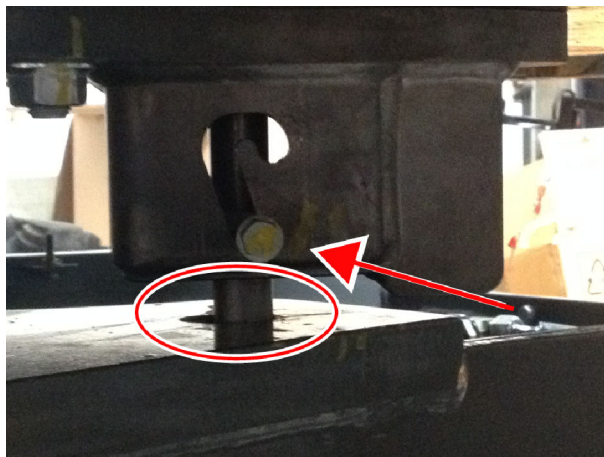

D - Operation instructions

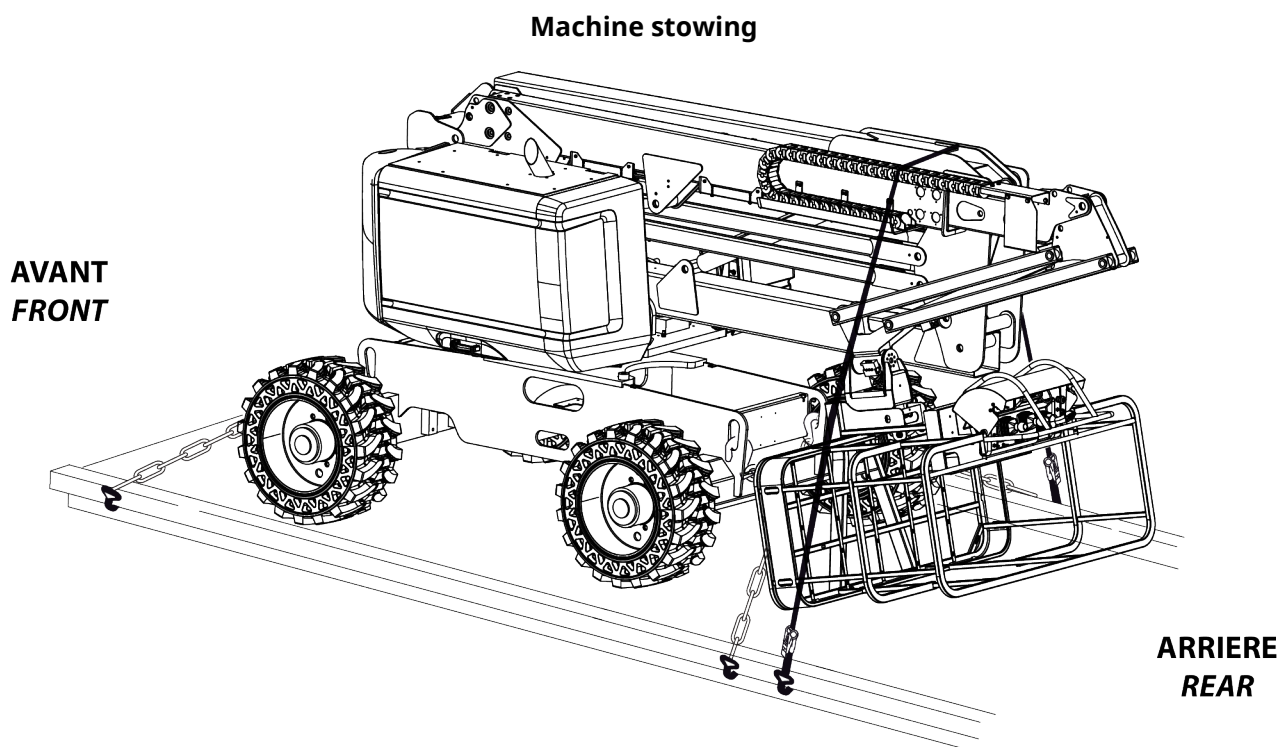

N.B.:-SECURE TURNTABLE WITH THE TURNTABLE LOCKING PIN BEFORE TRAVELING LONG DISTANCES OR HAULING MACHINE ON A TRUCK.

5.3 Unloading

Before unloading, check that the machine is in good condition and that it has not suffered any damage during transport.

- Remove the turntable rotation locking pin ( Section D - Machine layout).
- Remove the tie downs.
- Select low drive speed at the platform control box.
- Start the machine from platform control box.



Upon starting a machine that has been secured and transported, the safety system may detect a false overload preventing all movement from the platform control box.

To reinstate the system, lift the jib a few centimetres (inches) using the ground control box.

5.4 Towing



In the event of a machine breakdown, the machine can be towed a short distance to load it onto a transport vehicle:

- Ensure that no one is in the platform during towing.
- Ensure boom is in the stowed position and the turntable is locked, prior to towing.
- The platform must be empty.

To tow a broken-down machine, disconnect the wheel drive hubs.

In the towing configuration, the machine braking system is inactive. Use a drawbar to avoid any risk of accident:

- Do not exceed the maximum freewheel speed (Refer to  B 4.1 - Technical specifications).

D - Operation instructions

- Do not use on a slope with a gradient greater than 25%.



Perform these operations on flat, horizontal ground. Block the wheels to immobilize the machine. The machine is in free wheel mode, so the braking system is not active.

5.4.1 Disengaging the drive hubs

- To manually unbrake gearbox, loosen approx. 7 turn the center screw to release the brake.



Be sure not to extract the screw.

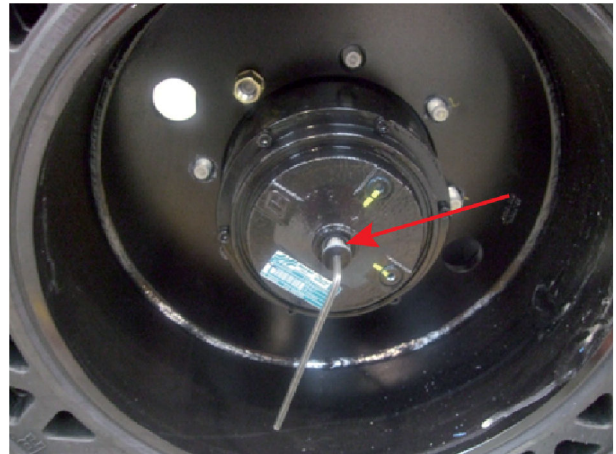

When drive hubs are disengaged, the machine is in free wheel mode and the brake system no longer functions.

5.4.2 Re-engaging the drive hubs

- To return machine to normal operation and braking, reverse the steps performed in disengaging the drive hubs.



Carry out a few driving movements. The drive hubs are now re-engaged.

5.5 Storage



The machine can be stored in a designated area when not in use. If it is stored for more than 3 months without being used, an inspection must be carried out before it is put back into service.



For engine storage condition follow engine supplier operator and maintenance manuals.

Machine must be parked in a protected/designated area with the boom in a stowed configuration, however the boom can be raised but must not be extended. Make sure there is no load in the platform.



At the ground control box, set the key control box activation (22) to the  to shut OFF the machine.

Ensure that the turntable rotation locking pin is removed and stored properly.

Remove the ignition key to prevent unauthorized operation of the machine.



Storing of the machine with an obstacle under the boom structure is forbidden.



To avoid any risk of corrosion on rods of cylinders during a storage period of more than 1 month:

- In a normal atmospheric environment: perform a complete cycle for the cylinders every 2 months while they are in storage.

D - Operation instructions

- In harsh environments (high levels of salinity in the atmosphere: close to the sea, industrial environment with chloride emissions and/or humidity >70%), we recommend applying the following protection process:
 - Wash and rinse the entire machine with plenty of clean water.
 - Dry all the cylinder rods using an air gun.
 - Apply a solvent-based oil leaving an oily film after evaporation of the solvent directly to all rods left exposed when the machine is in storage position.
 - Re-apply the product every month.



After washing the machine, make sure it is fully air-dry and does not contain moisture on corrosive parts (cylinders rods for example). Do not wash electrical components with a high pressure washer. Wipe away dirt from around electrical components with a dry cloth.

5.6 Lifting operation

During loading / unloading operation, if it becomes necessary to lift the machine using an overhead crane, it is important to respect the following:

- Put the machine in stowed position, boom and arm fully retracted and lowered.
- Ensure the platform is empty.
- Rotate the turret and the jib to the configuration in the photos below.
- Lock the turret with turret locking pin.
- Verify that lifting accessories are in good operation and match the technical specifications listed below. It is important that the lifting devices are attached only to the designated lifting eyes.
- Each of the slings used for lifting the machine must be adjusted to keep the machine level and to minimize the risk of damage to the machine.



- Anchorage point for lifting are identified / labeled by the following symbol .
- ONLY trained and authorized personnel should attempt to lift the machine.



Never lift the machine with slings attached to counterweight.

D - Operation instructions

Procedure for the use of slings

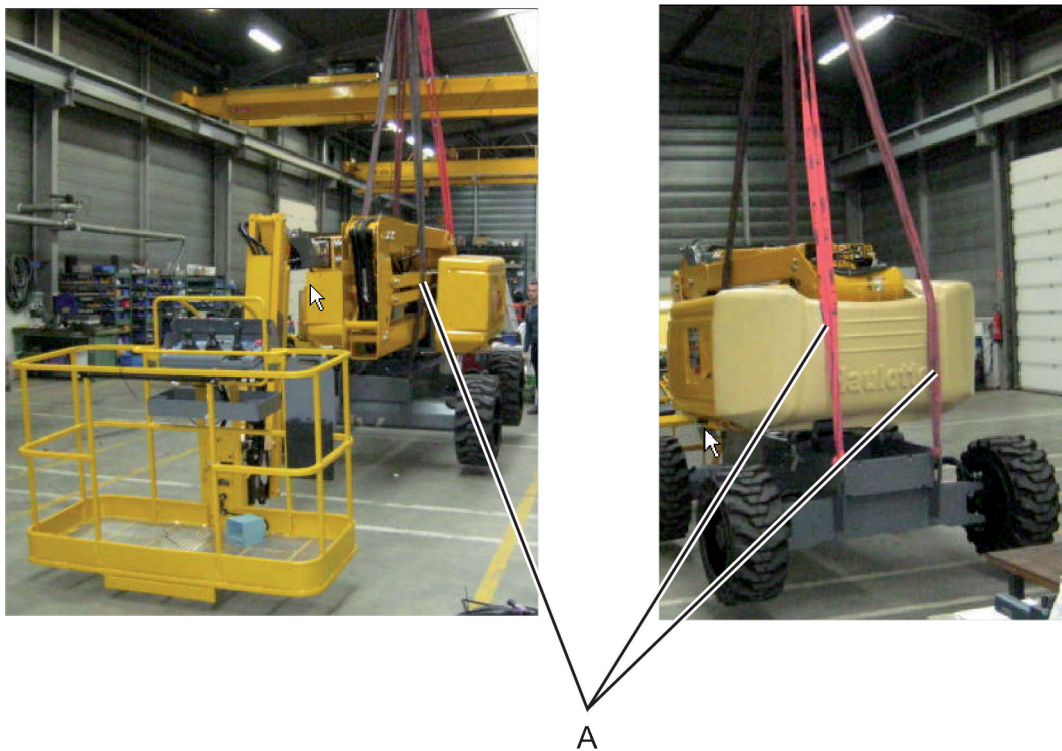

	Number of shackles	Number of slings	Length	Maximum load per sling and shackle
A	4	4	5 m (16 ft 5 in)	3000 daN (6744 lbf)

D - Operation instructions

6 Cold Weather Recommendations

In cold weather conditions, allow engine to run for at least 5 min to warm up ; before operating any function thereby preventing any damage to the hydraulic system.

In extreme cold conditions, machines should be equipped with optional cold start kits.

Attempting to start engine when temperature is in the negative range, may require the use of a booster battery.

If engine fails to start, do not crank for an extended time. Allow starter to "cool off" for a few minutes before attempting again. If engine fails after several attempts, refer to the engine maintenance manual.

N.B.--INITIAL STARTING SHOULD ALWAYS BE PERFORMED FROM THE GROUND CONTROL BOX.

6.1 Engine oil

The correct SAE viscosity grade of oil is determined by the minimum ambient temperature during cold engine start-up, and the maximum ambient temperature during engine operation.

In general, use the oil with the lowest viscosity to meet starting temperature requirements.

Engine oil viscosity		
Viscosity index	Ambient temperature	
	Minimum	Maximum
SAE 0W20	-40°C (-40°F)	10°C (50°F)
SAE 0W30	-40°C (-40°F)	30°C (86°F)
SAE 0W40	-40°C (-40°F)	40°C (104°F)
SAE 5W30	-30°C (-22°F)	30°C (86°F)
SAE 5W40	-30°C (-22°F)	40°C (104°F)
SAE 10W30	-20°C (-4°F)	40°C (104°F)
SAE 15W40	-10°C (14°F)	50°C (122°F)

Classification API

Fuel type	Engine oil classification
Low sulfur fuel ≤ [0.05% (500 ppm)] Sulfur content < 0.50% (5000 ppm)	APICJ-4 or CK-4 (If fuel with a high sulfur content is used, change the engine oil more frequently (reduce the intervals between each oil change by approximately half))

N.B.--FOR ADDITIONAL ENGINE OIL RECOMMENDATIONS, REFER TO THE ENGINE MANUAL PROVIDED WITH THE MACHINE.

D - Operation instructions

6.2 Hydraulic oil









External environmental conditions can reduce performance of the machine if the hydraulic oil temperature does not reach its optimum range.

It is recommended to use the hydraulic oil according to weather condition. Refer to the table below.

Environmental conditions	SAE Viscosity grade
Ambient temperature between - 35°C (- 31°F) and + 35°C (+ 95°F)	HV 32 ARTIC
Ambient temperature between - 15°C (5°F) and + 40°C (+ 104°F)	HV 32
Ambient temperature between 0°C (+ 32°F) and + 45°C (+ 113°F)	HV 68

N.B.:-IT IS RECOMMENDED TO REPLACE LOW TEMPERATURE OIL AS THE AMBIENT TEMPERATURE REACHES + 15°C (59°F). IT IS NOT ADVISABLE TO MIX OILS OF DIFFERENT BRANDS OR TYPES.

6.3 Preheating operation

- Activate a control box by turning Control box activation key control (22)  to the desired position  or .
- The ground control box indicators (10) , (13) , (15) , and (19)  light up. The engine is in pre-heating mode.
- Upon the extinction of the LEDs, the engine is ready to start.
- Press the engine start button (16) , to start the engine.

E - General Specifications

1	Machine dimensions.....	3
2	Major component masses.....	6
3	Acoustics and vibrations.....	7
4	Wheel/Tire assembly.....	8
4.1	Technical specifications.....	8
4.2	Inspection and maintenance.....	8
5	Options.....	11
5.1	Compatibility.....	11
5.2	Advanced Access Management - Access control and usage restriction.....	11
5.3	Platform.....	24
5.4	On-board generator.....	25
5.5	Glazier's kit.....	27
5.6	Plumber's kit.....	30
5.7	Activ' Shield Bar - Secondary crush risk reduction system (If fitted)	34
5.8	Sand tires.....	37

E - General Specifications

1 Machine dimensions

Stowed / Transport position: Configuration that takes the minimum floor space necessary for storage and / or delivery of the machine-Access position.

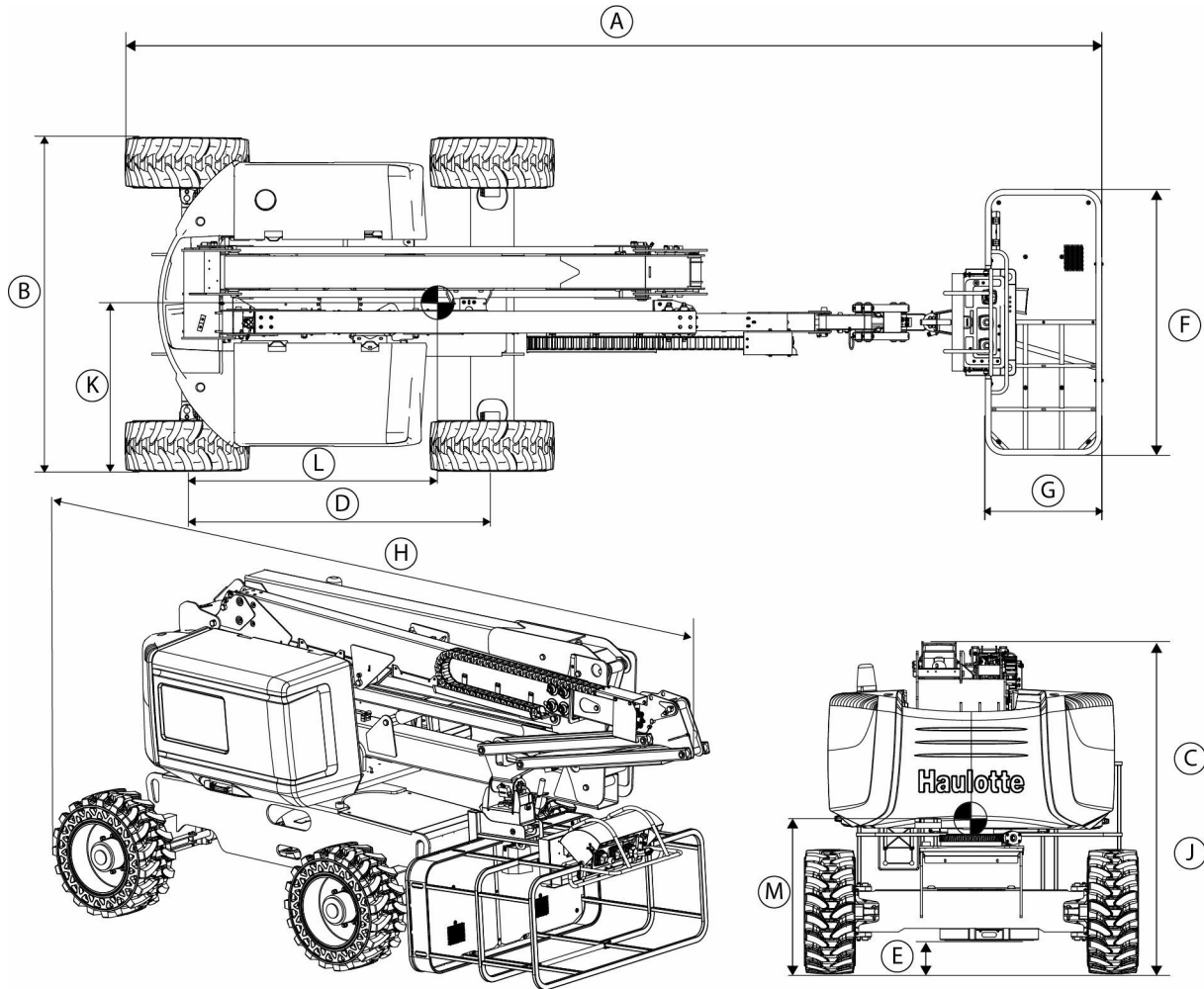

Machine		HA16RTJ	
Marking	Specifications - Dimensions	SI	Imp.
A	Overall length of machine	6,75 m	22 ft 2 in
B	Overall width of machine	2,30 m	7 ft 7 in
C	Overall height of machine	2,30 m	7 ft 7 in
D	Wheel base	2,10 m	6 ft 11 in
E	Ground clearance	38 cm	15 in
F X G	Platform dimensions	1,8 x 0,8 m	5 ft 11 in x 2 ft 7 in
H	Storage length	5,05 m	16 ft 7 in
J	Storage height	2,40 m	7 ft 10 in

E - General Specifications

Machine		HA16RTJ	
K	Center of gravity -Y	1,15 m	3 ft 9 in
L	Center of gravity - X	1,23 m	4 ft
M	Center of gravity - Z	1,18 m	3 ft 10 in
	Outside turning radius - 2WS	4,5 m	14 ft 9 in
	Inside turning radius - 2WS	2,4 m	7 ft 10 in

Machine		HA16RTJ O - HA46RTJ O	
Marking	Specifications - Dimensions	SI	Imp.
A	Overall length of machine	6,75 m	22 ft 2 in
B	Overall width of machine	2,30 m	7 ft 7 in
C	Overall height of machine	2,30 m	7 ft 7 in
D	Wheel base	2,10 m	6 ft 11 in
E	Ground clearance	38 cm	15 in
F X G	Platform dimensions	1,8 x 0,8 m	5 ft 11 in x 2 ft 7 in
H	Storage length	5,05 m	16 ft 7 in
J	Storage height	2,40 m	7 ft 10 in
K	Center of gravity -Y	1,15 m	3 ft 9 in
L	Center of gravity - X	1,23 m	4 ft
M	Center of gravity - Z	1,18 m	3 ft 10 in
	Outside turning radius - 2WS	4,5 m	14 ft 9 in
	Inside turning radius - 2WS	2,4 m	7 ft 10 in

Machine		HA16RTJ PRO - HA46RTJ PRO	
Marking	Specifications - Dimensions	SI	Imp.
A	Overall length of machine	6,75 m	22 ft 2 in
B	Overall width of machine	2,30 m	7 ft 7 in
C	Overall height of machine	2,30 m	7 ft 7 in
D	Wheel base	2,10 m	6 ft 11 in
E	Ground clearance	38 cm	15 in
F X G	Platform dimensions	1,8 x 0,8 m	5 ft 11 in x 2 ft 7 in
H	Storage length	5,05 m	16 ft 7 in

E - General Specifications

Machine		HA16RTJ PRO - HA46RTJ PRO	
J	Storage height	2,40 m	7 ft 10 in
K	Center of gravity - Y	1,15 m	3 ft 9 in
L	Center of gravity - X	1,23 m	4 ft
M	Center of gravity - Z	1,18 m	3 ft 10 in
	Outside turning radius - 4WS	3,75 m	12 ft 4 in
	Inside turning radius - 4WS	2 m	6 ft 7 in

E - General Specifications

2 Major component masses

N.B.:-MASSES MEASURED WITH EMPTY TANKS.

Component	HA16RTJ	HA16RTJ O - HA46RTJ O	HA16RTJ PRO - HA46RTJ PRO
Frame assembly mass	1950 kg - 4,300 lbs	2150 kg - 4,741 lbs	2 300 kg - 5,072 lbs
- Mass of each wheel	143,7 kg +/- 2,9 kg (316,8 lbs +/- 6,39 lbs)		
Turret assembly mass	760 kg - 1,676 lbs		
- Counterweight mass - Turntable	1365 kg - 3,010 lbs / 1465 kg - 3,230 lbs ⁽¹⁾	1365 kg - 3,010 lbs	1465 kg - 3,230 lbs
- Engine compartment mass	255 kg - 562 lbs		
- Battery mass	21 kg - 46 lbs		
Boom assembly mass	420 kg - 926 lbs		
Arm assembly mass	860 kg - 1,896 lbs		
Jib assembly mass	100 kg - 221 lbs		
Platform assembly mass	200 kg - 441 lbs		

⁽¹⁾ Refer to the machine's identification plate

E - General Specifications

3 Acoustics and vibrations

The acoustics and vibrations specifications are based upon the following conditions:

- The airborne noise emissions at workstation are determined per European Directive 2006/42/CE.
- The guaranteed sound power level LWA (displayed on the product) is determined per European Directive 2000/14/CE.
- The vibrations transmitted by the machinery to the hand/arm system and to the whole body are determined per European Directive 2006/42/CE.

Specifications	
Sound pressure level at workstation	80 dBA
Guaranteed sound power level	104 dBA
Vibrations hand/arm	Vibration transmitted by this MEWP to the hand-arm does not exceed 2,5 m/s ² (98,4 in/s ²)
Vibrations whole body	Vibration transmitted by this MEWP to the whole body does not exceed 0,5 m/s ² (19,6 in/s ²)

E - General Specifications

4 Wheel/Tire assembly

4.1 Technical specifications

Component	Standard wheel	Variant wheels
Reference number	830 x 285	
Type	Solid Tyre (Curred - on)	
Wheel mass	143,7 kg +/- 2,9 kg (316,8 lbs +/- 6,39 lbs)	151,5 kg +/- 4,5 kg (334 lbs +/- 10 lbs)
Size	830 mm x 285 mm - (2 ft 7 in / 0 ft 9 in)	
Torque	320 Nm (236 lbs ft)	

4.2 Inspection and maintenance



The tire and rim are bonded together, both must be replaced if either is damaged.

Wheels replacement must be made in the following cases

- Deformation or cracks on the rim.
- De-bonding between the interface of the steel and the rubber.
- Uniform wear to the wearing line:
 - 830 x 285 wheel: Ø 830 mm / 33 in
 - 1025 x 365 wheel (Optional) : Ø 962 mm / 41 in
 - 1025 x 365 wheel (Optional) : Ø 962 mm / 41 in



E - General Specifications

- Non-linear wearing of the tread profile (> 10%)

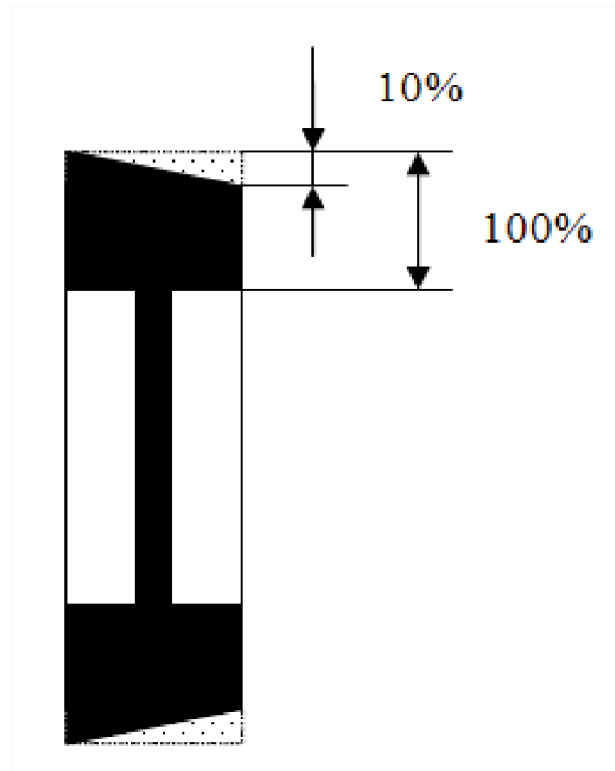

- 1 wheel stud is completely torn.
- 2 successive wheel studs are partially torn.
- 2 aperture holes are cut.



E - General Specifications



Tires and rims are critical components for the stability of the machine. For safety reasons

- Use only HAULOTTE® spare parts according to the technical characteristics of the machine. Refer to the spare parts catalog.
- Do not replace factory-installed tires with tires of different specifications or ply rating.
- Never replace a solid (rigid) tire with a foam-filled or a pneumatic (air-filled) tire.

Procedure of replacement

- Loosen the wheel nuts on the wheel to be removed.
- Raise the machine using a jack or a hoist.
- Remove the wheel nuts.
- Remove the wheel.
- Install the new wheel.
- Lower the machine to the ground.
- Tighten the wheel nuts evenly to the torque of 320 Nm (236 ft lbs).



Check the tightening torque of the wheel nuts every 200 h of operation

N.B.-:IF A WHEEL HAS BEEN REPLACED, LOOK AT THE DIRECTION OF THE CLAMPS (WHICH INDICATES ROTATION IN THE AV DIRECTION) TO MAKE SURE IT IS CORRECTLY INSTALLED

E - General Specifications

5 Options

5.1 Compatibility



Before installing any options or accessories, consult HAULOTTE® to check compatibility.

5.2 Advanced Access Management - Access control and usage restriction

5.2.1 Description

Access control and usage restriction are options available on a machine equipped with the SHERPAL solution. These options enable the use of the machine to be limited.

These limitations are set and managed from the MyHaulotte platform by the fleet manager.

5.2.1.1 Access control

The purpose of the access control is to prohibit lifting by an unauthorised operator. Access to the machine is via the RFID code and/or RFID board on the keyboard of the remote RFID reader.

Access control also allows the machine owner to block access to the machine's diagnostic screens for users without the level 3 code (Code available to authorised technicians only) . The level 3 code must be entered on the machine's screen.

5.2.1.2 Usage restriction

The usage restriction is a machine-related limitation. The usage restriction restricts the use of the machine when it is outside of the conditions of use predefined by the manager.

This function can be set from the MyHaulotte platform by those with the appropriate roles and rights.

The configurable conditions of use are as follows:

- GEOFENCE:-Authorisation for geolocalised use
- TIMEFENCE:-Authorisation for use according to defined time slots
- Remote restriction:-Forced activation of a usage restriction, regardless of the GEOFENCE and TIMEFENCE conditions
- Tracker fault:-Activation of the restriction if tracker in default

When the machine is outside of its conditions of use, only movements allowing micro-speed movement and folding are authorized.

When the machine is subject to a restriction, a message indicates this on the screen of the ground control panel. The user in the basket is notified by the indicator light on the control panel  which flashes at a frequency of 1s ON - 1s OFF.

5.2.1.3 GEOFENCE

The manager can activate the GEOFENCING restrictions in order to limit the machine's use inside a so-called AUTHORIZED geographical zone or outside a so-called PROHIBITED geographical zone, which he has defined. If the machine leaves this perimeter, its functionality will be restricted..

5.2.1.4 TIMEFENCE

The manager can activate the TIMEFENCING restrictions in order to restrict the usage during the defined period (Day, Time slot, ...) . If the machine is used outside of the time slot defined by the manager, its functionalities will be restricted.

A GEOFENCING and/or TIMEFENCING restriction becomes active after the machine is folded.

5.2.1.5 Remote restriction

It is also possible for the fleet manager to set a restriction remotely.

This is equivalent to the forced activation of a restriction, independent of the temporary TIMEFENCING or geolocalized GEOFENCING conditions of use.

E - General Specifications

5.2.2 Additional functions

5.2.2.1 Access control and usage restriction combination

The access control can be combined with the machine's usage restriction. If access control and usage restriction are active, the combination of the two applies so that the user is subject to the constraints of the strongest restriction.

5.2.2.2 tracker default function

This function allows you to force activation of the restriction in the event of a problem (e.g. tracker removed, unplugged or defective)..

This function is deactivated by default. This function can be activated on the Machine Sheet from the MyHaulotte platform.

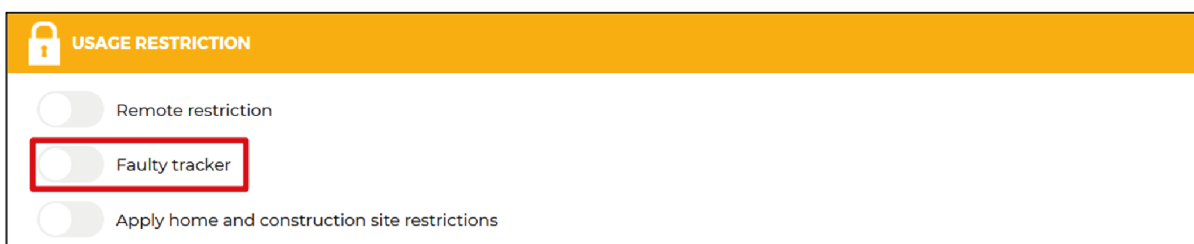
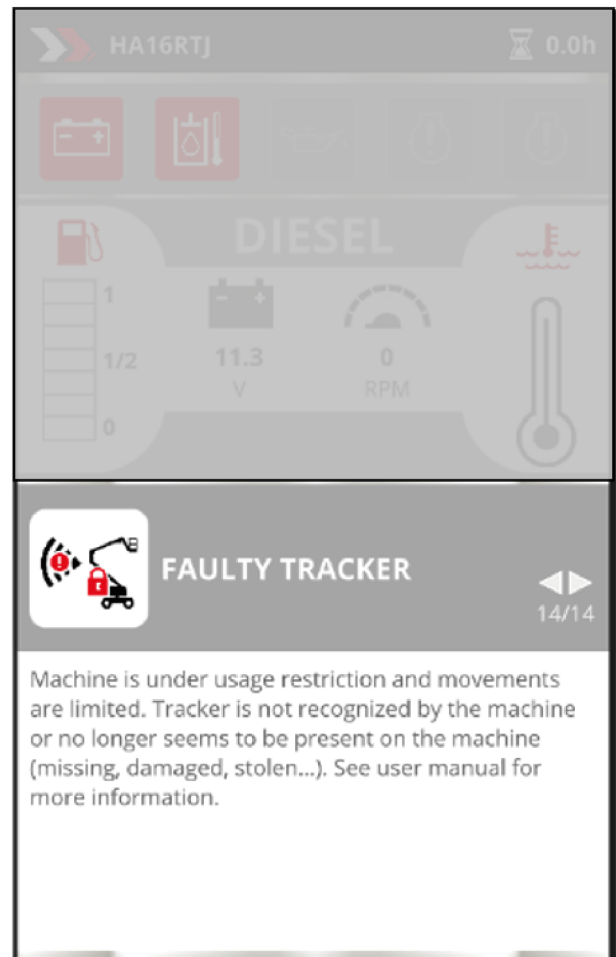

E - General Specifications

5.2.3 SUPER USER status

The fleet manager can add Super User status to a user from the MyHaulotte platform. The Super User profile enables the machine to be used, even if it is subject to a usage restriction.

The Super User profile can be connected to one or more machines.

The Super User profile can then start these machines using the PIN code generated by the fleet manager on MyHaulotte or using the RFID card assigned to him.

5.2.4 Code for removing restrictions

This code enables all restrictions to be permanently removed from a machine (Access control, usage restriction and remote restriction).

The code for removing restrictions is generated by the fleet manager on MyHaulotte. This code must then be entered on the machine's Restrictions Removal Code screen to unlock it permanently.

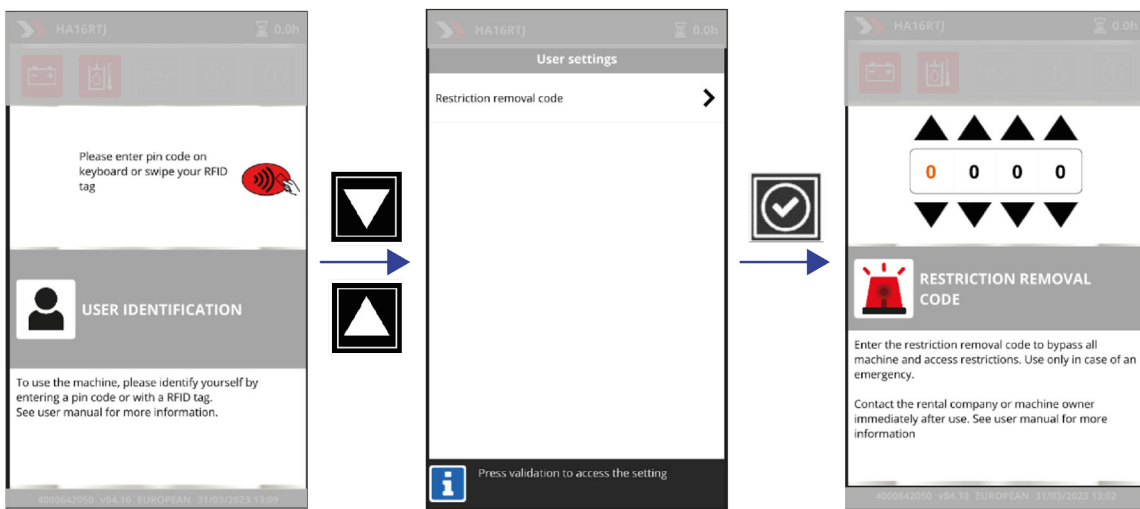

Enter the restriction removal code.



Permanently disable the restrictions and access control.

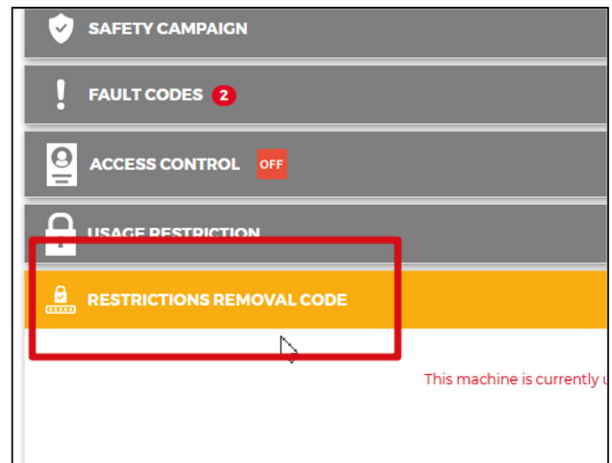

E - General Specifications

5.2.5 Operation

5.2.5.1 Using a machine with access control enabled

The following screen appears when starting up (energizing) the machine.

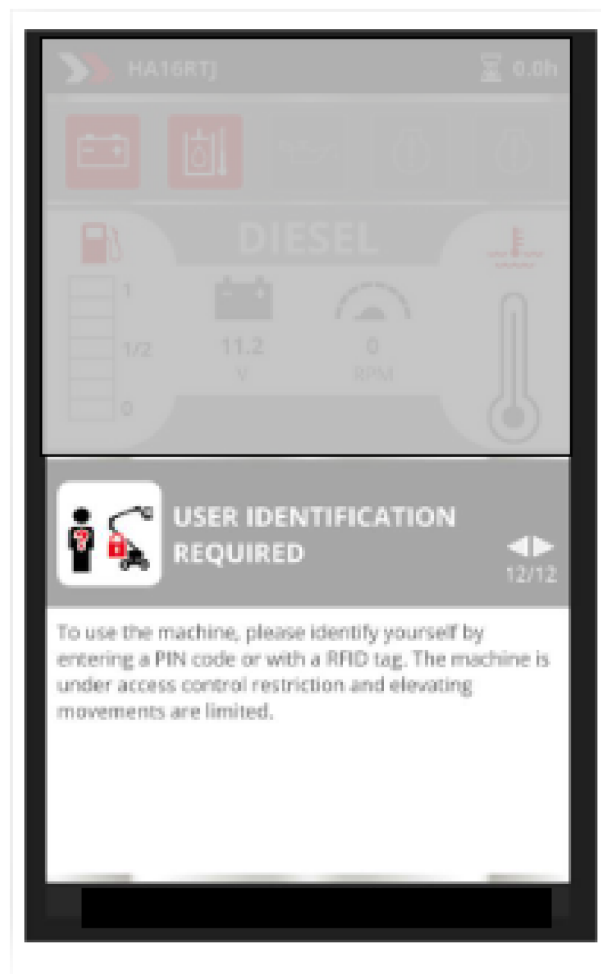

The machine can then be started by:

- A user with a User Identification start-up code. This code must be entered on the remote RFID keyboard.
- A Haulotte® technician with a Haulotte technician Identification. The level 3 code must be entered on the machine's screen.
- A user with a Restrictions Removal Code. This code is owned by the fleet manager or machine owner. The code is generated on the MyHaulotte platform and must be entered on the machine's screen. This code cannot be provided by Haulotte®.

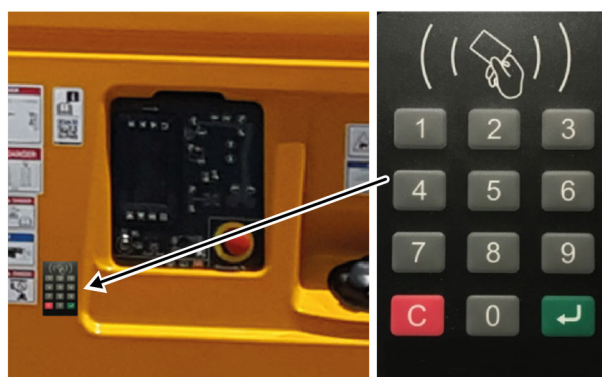



E - General Specifications

Start-up when access control is enabled:

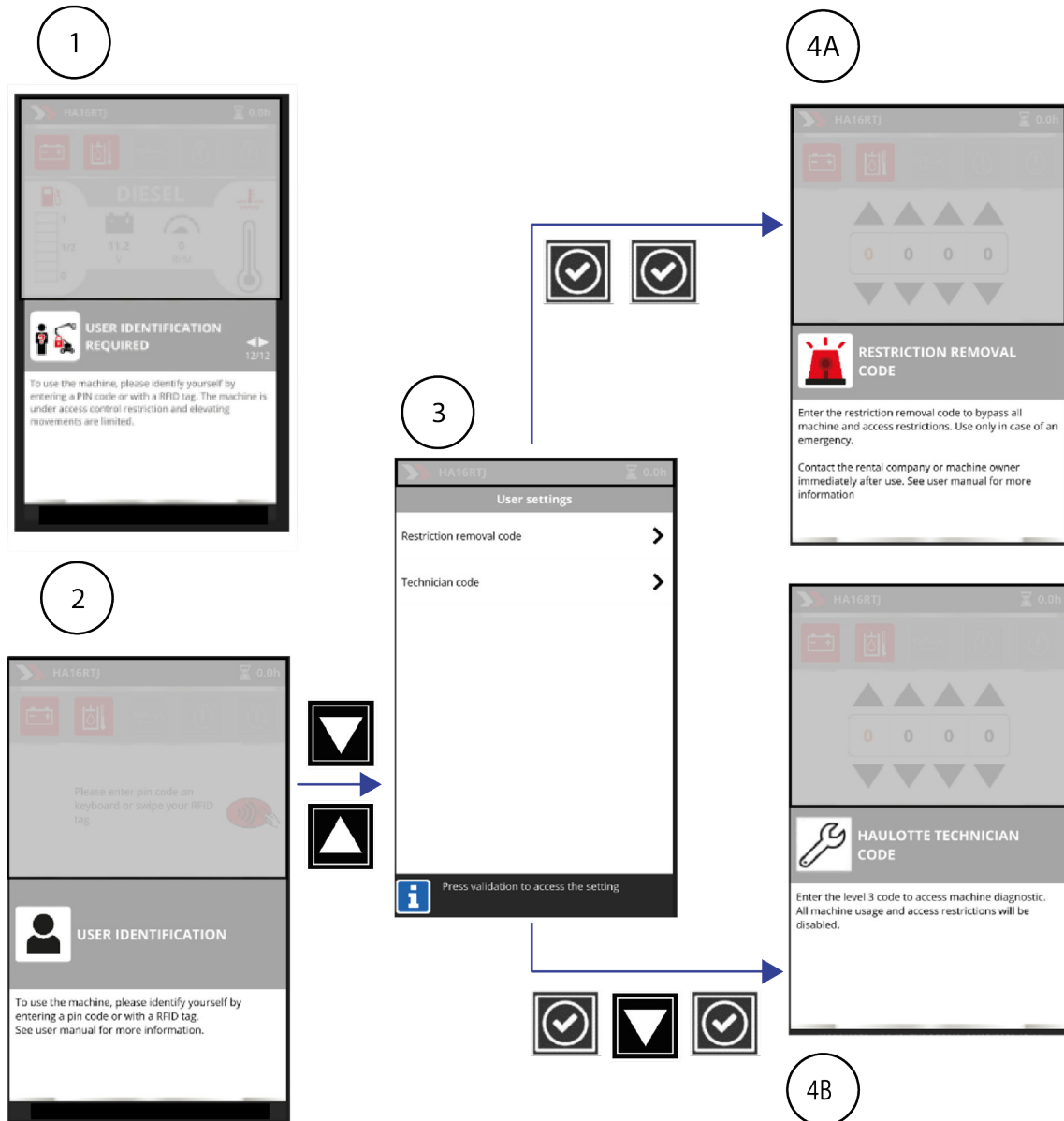
- Enter the access code or use the RFID swipe card.
- Enter the Super User access code or use the Super User RFID swipe card.
- An authorized technician can use the level 3 code.
- Enter the restriction removal code on the machine's screen.



E - General Specifications

Marking	Actions
1	On the RFID keyboard, enter the PIN code or use an RFID card or enter the Super User code
2	/
3	/
4A	Enter the restriction removal code  Permanently disable the restrictions and access control. Return to normal operation.
4B	Enter the level 3 code  Temporary deactivation (until the machine is switched off) of the restrictions and access control.

E - General Specifications

5.2.5.2 Starting a machine with usage restriction enabled

Timefencing restriction activated and use within the time slot authorized

Conventional start-up without access code:

- The following screen indicates that a restriction is in place on the machine.

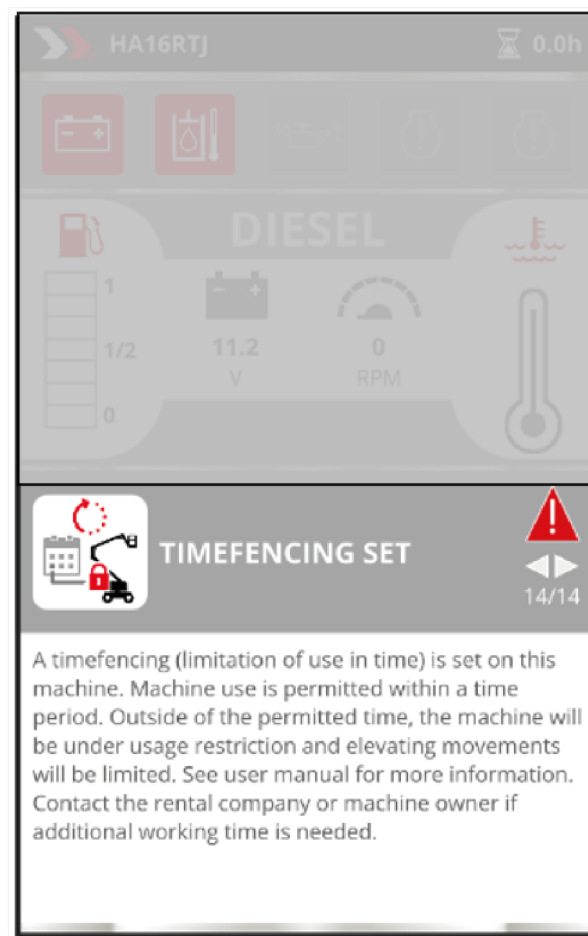



Timefencing restriction enabled and use outside range is permitted

Start-up when a TIMEFENCING usage restriction is programmed and enabled:

- A message on the screen indicates that a restriction is enabled.
- Enter a Super User access code or use the Super User RFID swipe card.
- An authorized technician can use the level 3 code.
- A user with a code can enter the restriction removal code on the machine's screen.

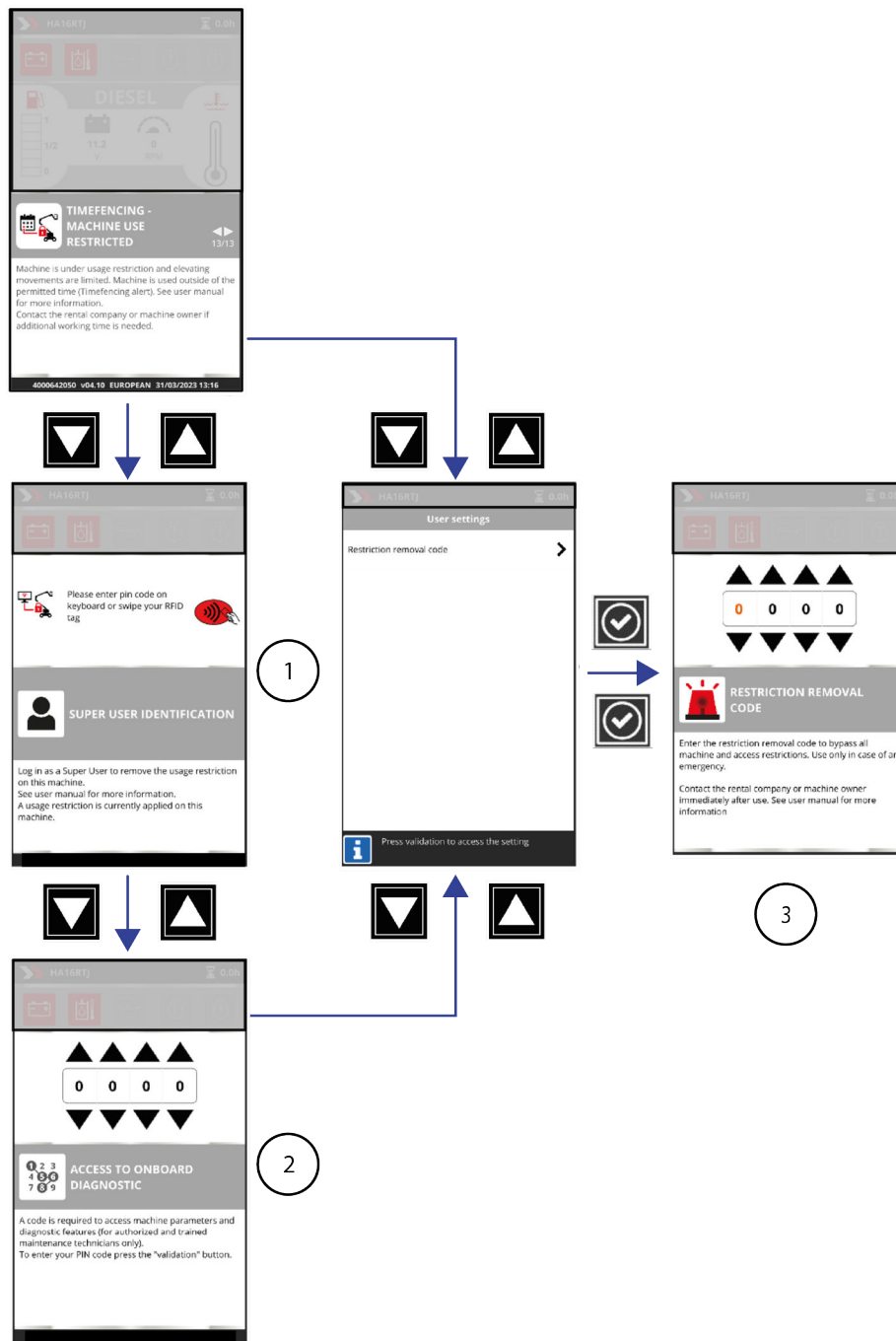
E - General Specifications



Marking	Actions
1	On the RFID keyboard, enter the PIN Super User code or use an RFID card or enter the Super User code
2	Enter the level 3 code  Temporary deactivation of restrictions and access control.
3	Enter the restriction removal code  Permanently disable the restrictions and access control. Return to normal operation.

E - General Specifications

Geofencing restriction enabled and used in an authorized geographical zone

Conventional start-up without access code:

- The following screen indicates that a restriction is in place on the machine.

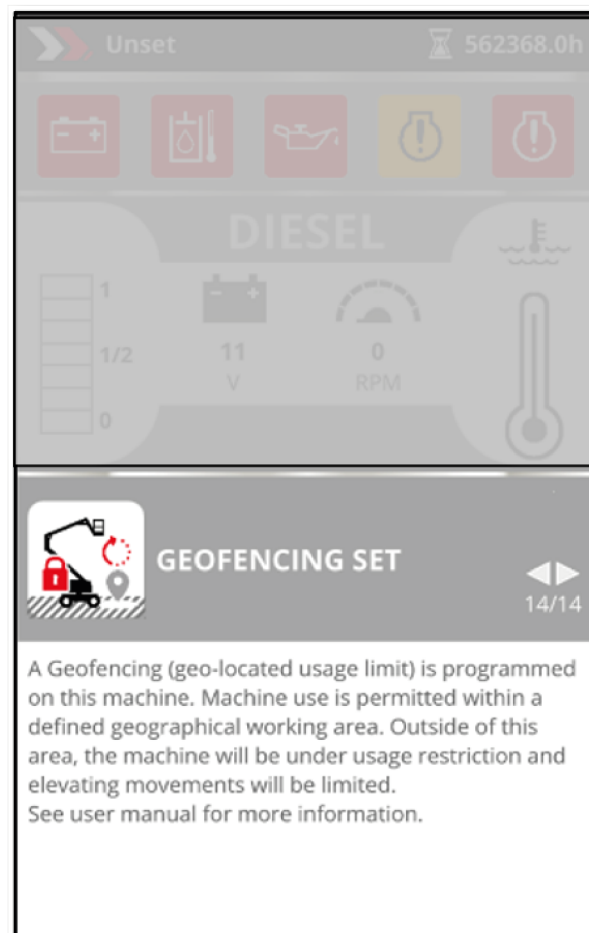



Geofencing restriction enabled and used outside of the authorized geographical zone

Start-up when a GEOFENCING usage restriction is programmed and enabled:

- A message on the screen indicates that a restriction is enabled.
- Enter a Super User access code or use the Super User RFID swipe card.
- An authorized technician can use the level 3 code.
- Enter the restriction removal code on the machine's screen.

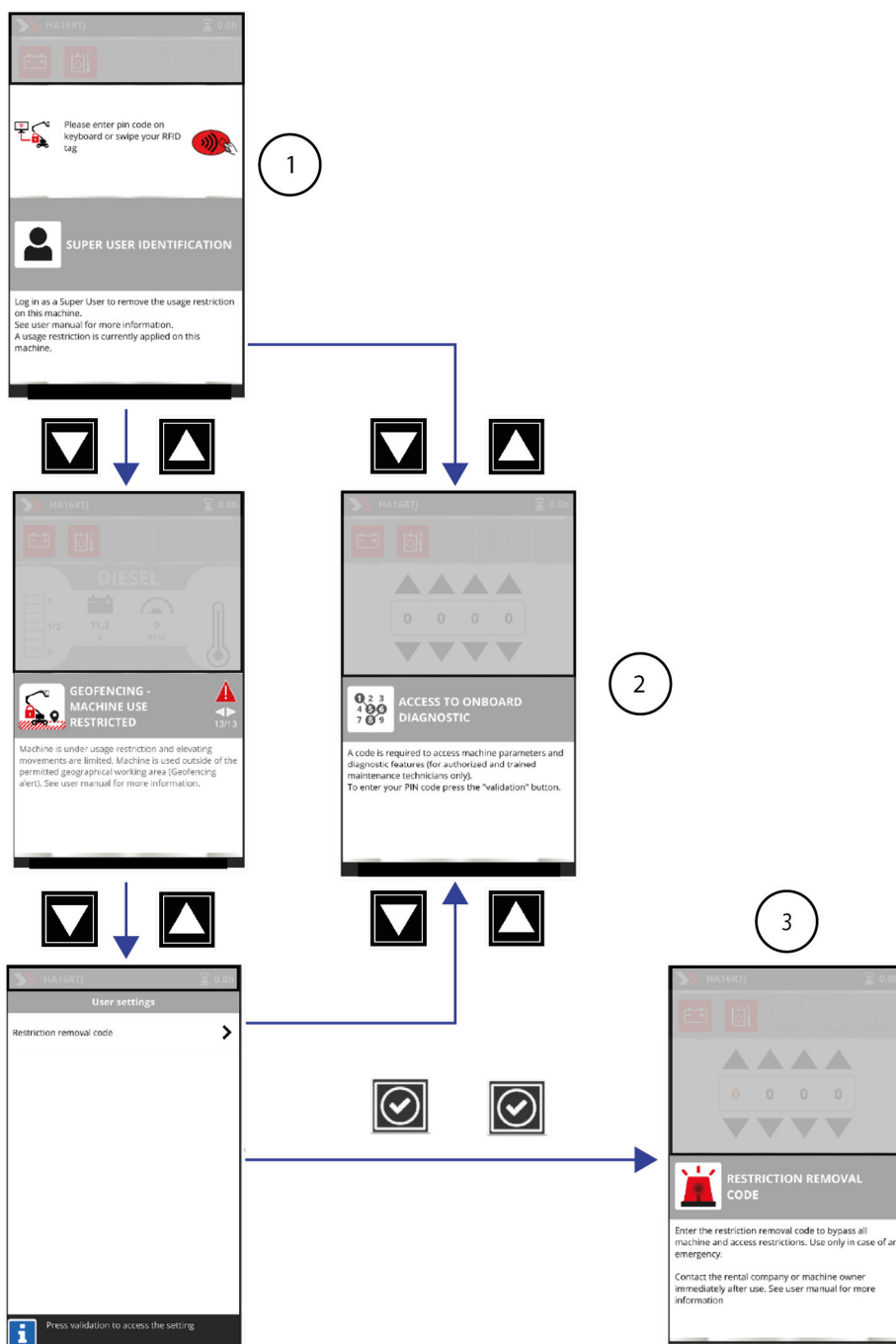
E - General Specifications



Marking	Actions
1	On the RFID keyboard, enter the PIN Super User code or use an RFID Super User card or enter the Super User code
2	 Enter the level 3 code Temporary deactivation of restrictions and access control.
3	 Enter the restriction removal code Permanently disable the restrictions and access control. Return to normal operation.

E - General Specifications



Remote restriction

Start-up when remote restriction is programmed and enabled:

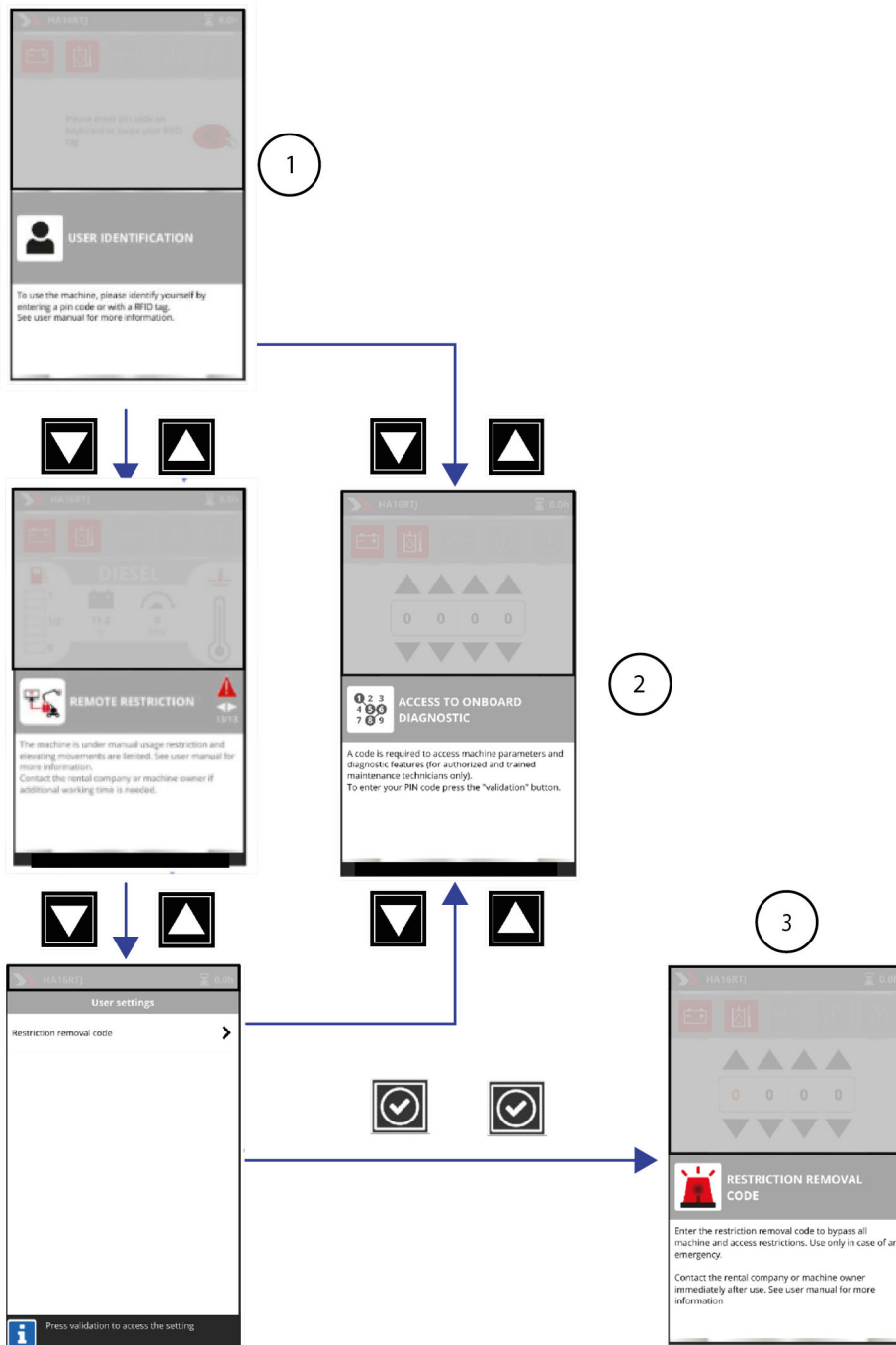
- A message on the screen indicates that a restriction is enabled.
- Enter a Super User access code or use the Super User RFID swipe card.
- An authorized technician can use the level 3 code.
- Enter the restriction removal code on the machine's screen.



E - General Specifications

Marking	Actions
1	On the RFID keyboard, enter the PIN Super User code or use an RFID Super User card or enter the Super User code
2	Enter the level 3 code  Temporary deactivation of restrictions and access control.
3	Enter the restriction removal code  Permanently disable the restrictions and access control. Return to normal operation.



E - General Specifications

Access control and usage restriction combination

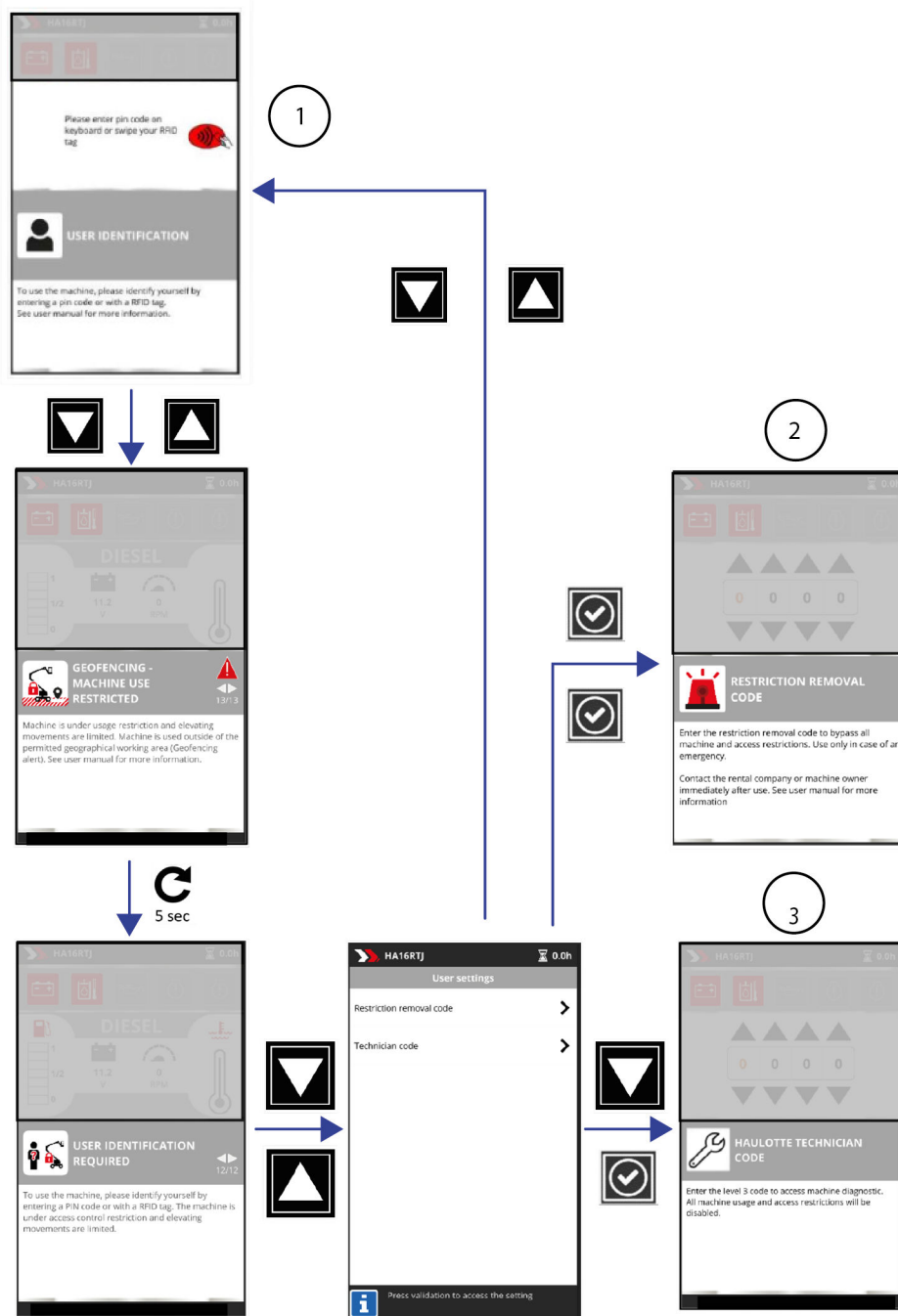
- Enter the machine's access code or use the RFID swipe card (the machine remains under restricted use) or use the RFID Super User swipe card or use the Super User code.
- An authorized technician can use the level 3 code.
- Enter the restriction removal code on the machine's screen.



E - General Specifications

Marking	Actions
1	On the RFID keyboard, enter the PIN code or use an RFID card or enter the Super User code
2	Enter the restriction removal code  Permanently disable the restrictions and access control. Return to normal operation.
3	Enter the level 3 code  Temporary deactivation of restrictions and access control.

5.3 Platform

Technical specifications

Type	HA16RTJ - HA16RTJ O - HA16RTJ PRO - HA46RTJ O - HA46RTJ PRO -		Platform entry
Small platform	Platform width	0,8 m - 2 ft 7 in	Swing gate
	Platform length	1,8 m - 5 ft 11 in	
Large platform	Platform width	0,91 m - 3 ft	Sliding bar
	Platform length	2,44 m - 8 ft	Swing gate

Sliding bar



E - General Specifications

Swing gate



5.3.1 Swing gate

5.3.1.1 Description

SWING GATE consists of a laterally mounted pivoting $\frac{1}{2}$ gate with closing latch, which enables a better access to platform. Spring loaded hinges and a latching mechanism allows the gate to swing inwards only.

5.3.1.2 Specifications

Width of the gate: 500 mm / 19.68 in.

5.3.1.3 Safety precautions



- The door forms part of the guardrail system and must be closed after entering the platform.



Pay attention to the toeboard when entering or leaving the platform.

5.3.1.4 Pre-operation instructions

- Check that the locking mechanism is correctly fastened.
- Check the hinges and latch operate correctly and are not deformed.
- Ensure that the gate returns automatically to the closed and fastened position after entering or exiting the platform.

5.4 On-board generator

5.4.1 Description

The optional socket on the platform is supplied by a hydraulically powered generator. The generator is located in the engine compartment. The generator is activated by a switch on the platform control box. The power output and voltage available at the socket depends on the option installed.

E - General Specifications

5.4.2 Characteristics

Nominal power output	Main output voltage	Alternating current frequency	Socket plug type	Regulation zone
3,5 kw	230 V	50 Hz	Single-phase	European community market
3,7 kw	115 V	50 Hz	Single-phase	United Kingdom market
3,7 kw	110 V	60 Hz	Single-phase	American market
6,5 kw	400 V	50 Hz	Three-phase	European conformity and Australian markets
9 kw	210 V	60 Hz	Three-phase	American market
9 kw	120 V	60 Hz	Single-phase	American market
12 kw	210 V	60 Hz	Three-phase	American market

N.B.-:IF MACHINE EQUIPPED WITH THE OPTION 9-KW:

- **THE MACHINE IS EQUIPPED WITH A THERMAL PROTECTION WHICH CUTS OFF THE ENGINE TO PREVENT OVERHEATING.**
- **TO AVOID THE THERMAL CUT-OFF, THE DUTY CYCLE AT MAXIMUM POWER SHOULD NOT EXCEED 5 MINUTES OF USE FOLLOWED BY 5 MINUTES OF PAUSE.**

5.4.3 Safety precautions



- Please read the instructions before using the option.
- Make sure that no one is beneath the platform.
- Check that the voltage required by the tool matches the voltage supplied by the socket.
- Do not overload the power circuit.
- Do not use electrical tools in water.
- Do not exceed the nominal output power.



Do not expose the platform socket to direct contact with a water beam or a pressure washer.

5.4.4 Pre-operation inspection



- Check that the generator is securely attached, that there are no missing or loose parts and no damage.
- Check the hoses before use to make sure there are no leaks or damage.
- Check the relay wiring.

E - General Specifications

5.4.5 Operation

Power on:

- Start the machine.
- Heat the engine for 15 min before any operation.
- From the platform control box, move the generator selector switch (79) to the right to activate the generator ( B - Platform control box) .
- Connect the tool to the socket.
- Connect or disconnect from the socket at any time.

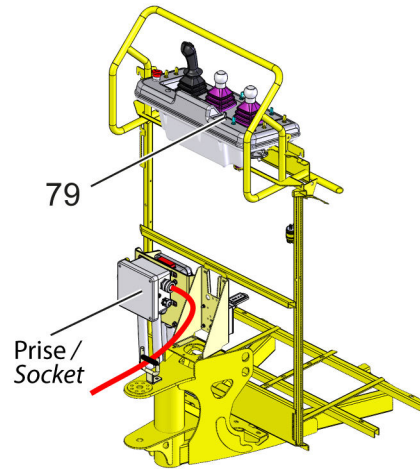

N.B.-:MACHINE MOVEMENTS ARE PREVENTED WHEN THE GENERATOR SWITCH IS ON.

Power off:

- Disconnect the tool from the socket.
- Move the generator selector switch (79) to the left to switch off the generator ( B - Platform control box) .
- Machine movements are once again functional.

5.5 Glazier's kit

5.5.1 Description

This attachment is an assembly designed to transport panels. This accessory comprises a tray that extends along the floor outside the platform. The panel(s) should be placed in the tray and secured to the guard rail with a strap (not supplied).

N.B.-:THIS TRAY CAN BE USED ONLY WITH A SIDE ENTRY PLATFORM.

5.5.2 Characteristics

Component	Characteristics
Maximum capacity	115 kg (220 lbs)
Weight of attachment	10 kg (22 lbs)
Maximum load surface	3 m ² (32 sq.ft)
Maximum allowable height of the panel	1,20 m (3 ft 11 in)
Maximum allowed wind	CE / UKCA / AS : 12,5 m/s - 45 km/h - 28 mph ANSI / CSA : 7 m/s - 25 km/h - 15 mph

5.5.3 Safety precautions



- Please read and assimilate the instructions before using the attachment.
- This attachment is designed for transporting panels. Do not use this attachment for transporting other types of load.
- Do not suspend loads.
- Do not overload the attachment and ensure that the equipment is correctly attached by means of a strap (not supplied).

E - General Specifications

- Do not exceed the maximum allowable platform capacity. The combined weight of the attachment, the panel(s), the occupants, the tools and any other equipment must not exceed the maximum allowable platform capacity.
- Do not load panels whose surface area exceeds the maximum authorized surface area. Exposing an additional surface area to the wind reduces machine stability. Do not install any other attachments that increase the surface area exposed to the wind.
- Check that the position of the panel is not reducing visibility during maneuvers in the work environment. Do not transport panels whose height exceeds the authorized limit.
- When maneuvering, ensure that a safe distance is maintained between the panel and the obstacles in the work environment.
- Do not use the machine if the wind speed exceeds the allowable limit with the attachment.

5.5.4 Pre-operation inspection



- Check that the tray has no cracks or other damage.
- Check that the cradle is correctly installed and secured to the platform.
- Check that the information decal is present on the cradle and is legible.
- Check that the strap is not twisted or torn.

5.5.5 Operation

- Load the panel onto the tray on platform.
- Secure the panel tray on the guardrail by means of a strap (not supplied) with the correct strength and dimensions.

Strapping example(s)-Large panel



Strapping example(s)-Small panel



E - General Specifications

5.5.6 Assembly/Dis-assembly

Tray

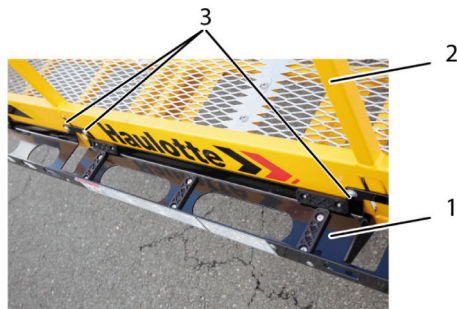

Marking	Description
1	Tray (Panel carrier)
2	Platform
3	Screws and nuts
4	Collars COLSON
5	Plastic protection

- Fix the tray (1) to the platform (2) using screws and bolts (3)
- Install plastic protection (5) on the handrail and attach it using collars (4)

N.B.-:-TORQUE REQUIREMENTS: 16 NM

- Pre-operation test: Place a load of 176 kg (390 lbs) on the carrier and carry out an inspection. Refer to the chapter on pre-operation inspection.

E - General Specifications

5.5.7 Specific decals

Location of the decals

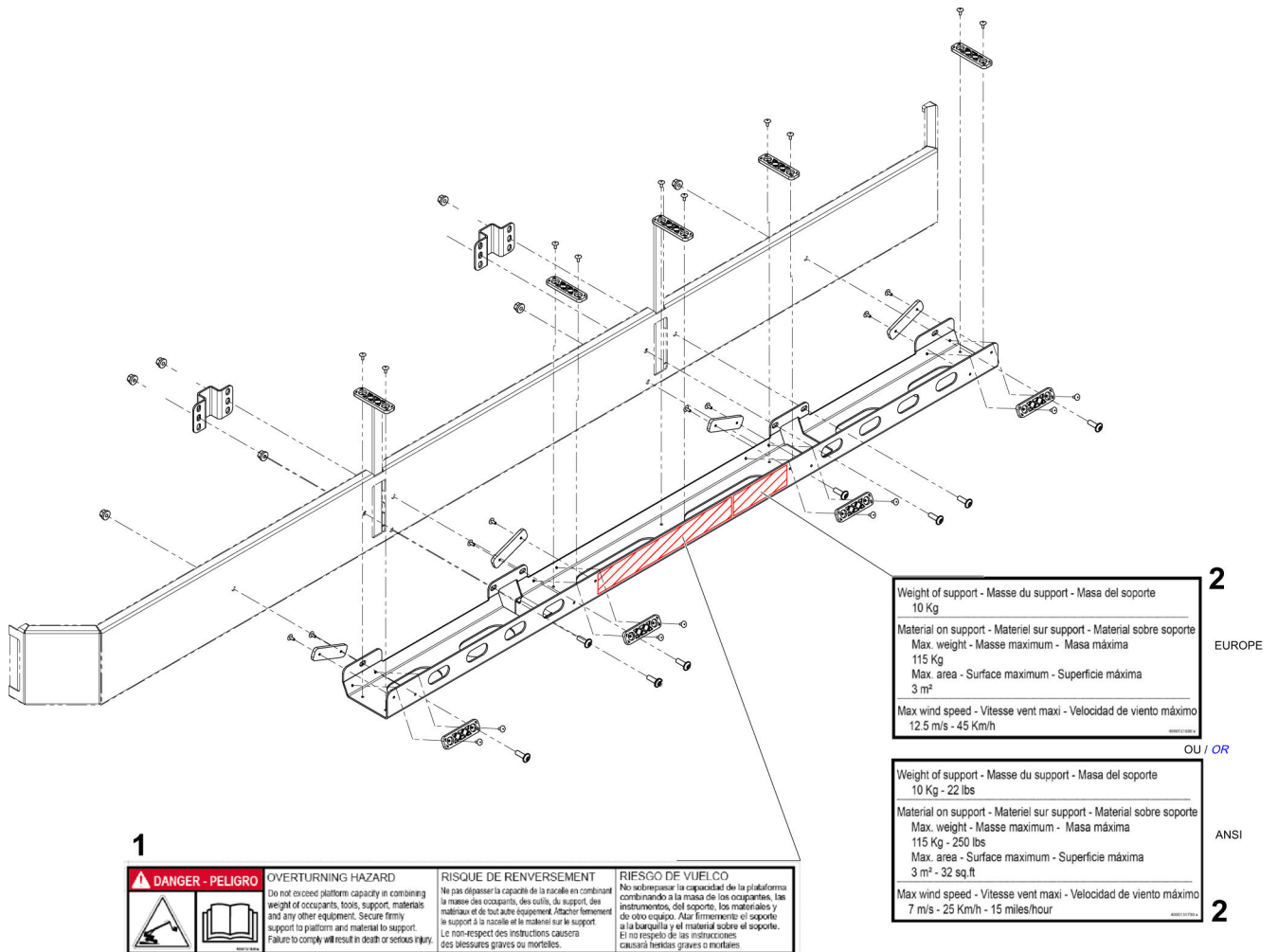

1

	OVERTURNING HAZARD Do not exceed platform capacity in combining weight of occupants, tools, support, materials and any other equipment. Secure firmly support to platform and material to support. Failure to comply will result in death or serious injury.	RISQUE DE RENVERSEMENT Ne pas dépasser la capacité de la nacelle en combinant la masse des occupants, des outils, du support, des matériaux et de tout autre équipement. Attacher fermement le support à la nacelle et le matériel sur le support. Le non-respect des instructions causera des blessures graves ou mortelles.	RIESGO DE VUELCO No sobrepasar la capacidad de la plataforma combinando a la masa de los ocupantes, las herramientas, del soporte, los materiales y de otro equipo. Ajar firmemente el soporte a la barquilla y el material sobre el soporte. El no respeto de las instrucciones causará heridas graves o mortales.
--	--	---	---

2

Weight of support - Masse du support - Masa del soporte 10 Kg	EUROPE
Material on support - Matériel sur support - Material sobre soporte Max. weight - Masse maximum - Masa máxima 115 Kg Max. area - Surface maximum - Superficie máxima 3 m ²	
Max wind speed - Vitesse vent maxi - Velocidad de viento máximo 12.5 m/s - 45 Km/h	
OU / OR	

2

Weight of support - Masse du support - Masa del soporte 10 Kg - 22 lbs	ANSI
Material on support - Matériel sur support - Material sobre soporte Max. weight - Masse maximum - Masa máxima 115 Kg - 250 lbs Max. area - Surface maximum - Superficie máxima 3 m ² - 32 sq.ft	
Max wind speed - Vitesse vent maxi - Velocidad de viento máximo 7 m/s - 25 Km/h - 15 miles/hour	
2	

Marking	Description	Quantity	Part number
1	Risk of overturning	1	40000131830
2	Equipment characteristics	1	CE / UKCA / AS : 4001267770 ANSI / CSA: 4000131730

5.6 Plumber's kit

5.6.1 Description

This attachment is an assembly designed to transport pipes and tubes. It comprises 2 cradles fixed to the rear side inside the platform. The load (material) should be placed in both the cradles and secured with a strap (not supplied).



This option is not compatible with the VITRIER KIT option.

E - General Specifications

5.6.2 Characteristics

Component	Characteristics
Weight of the carrier	8 kg (20 lbs)
Weight of the equipment on the carrier	80 kg (175 lbs)
Maximum load surface	0,8 m ² (Ø 0,32 m x 2,5 m) / 8.6 sq.ft (Ø 1 ft x 8.6 ft)
Maximum wind speed allowed	12,5 m/s - 45 km/h - 28 mph

5.6.3 Safety precautions



- Please read and assimilate the instructions before using the attachment.
- This attachment is designed for transporting pipes and tubes. Do not use this attachment for transporting other types of load.
- Do not suspend loads.
- Do not overload the attachment and ensure that the equipment is correctly attached by means of a strap (not supplied).
- Do not exceed the maximum allowable platform capacity. The combined weight of the attachment, load, the occupants, the tools and any other equipment must not exceed the maximum allowable platform capacity.
- Do not load tubes whose surface area exceeds the maximum authorized surface area. Exposing an additional surface area to the wind reduces machine stability. Do not install any other attachments that increase the surface area exposed to the wind.
- Do not use the machine if the wind speed exceeds the authorized limit of the attachment.
- The cradles should always be positioned such that they are within the platform. Position the bottom end of the cradles such that they are resting on the platform floor.
- When maneuvering, ensure you maintain a safe distance between the load and the obstacles in the work environment.

5.6.4 Pre-operation inspection



- Check that the cradle has no cracks or other damage.
- Check that the cradle is correctly installed and secured to the platform.
- Check that the information decal is present on the cradle and is legible.
- Check that the strap is not twisted or torn.
- Check that the position of the load and attachment is not obstructing access to the platform or the controls.
- Check that the position of the attachment and the load is not reducing visibility during maneuvers in the work environment.

5.6.5 Operation

- Position the load to rest on the 2 cradles.
- Center the load on the cradles.
- Securely attach the load to each cradle with strap of adequate strength and dimensions.

E - General Specifications

Strapping example(s)



5.6.6 Assembly-Dis-assembly

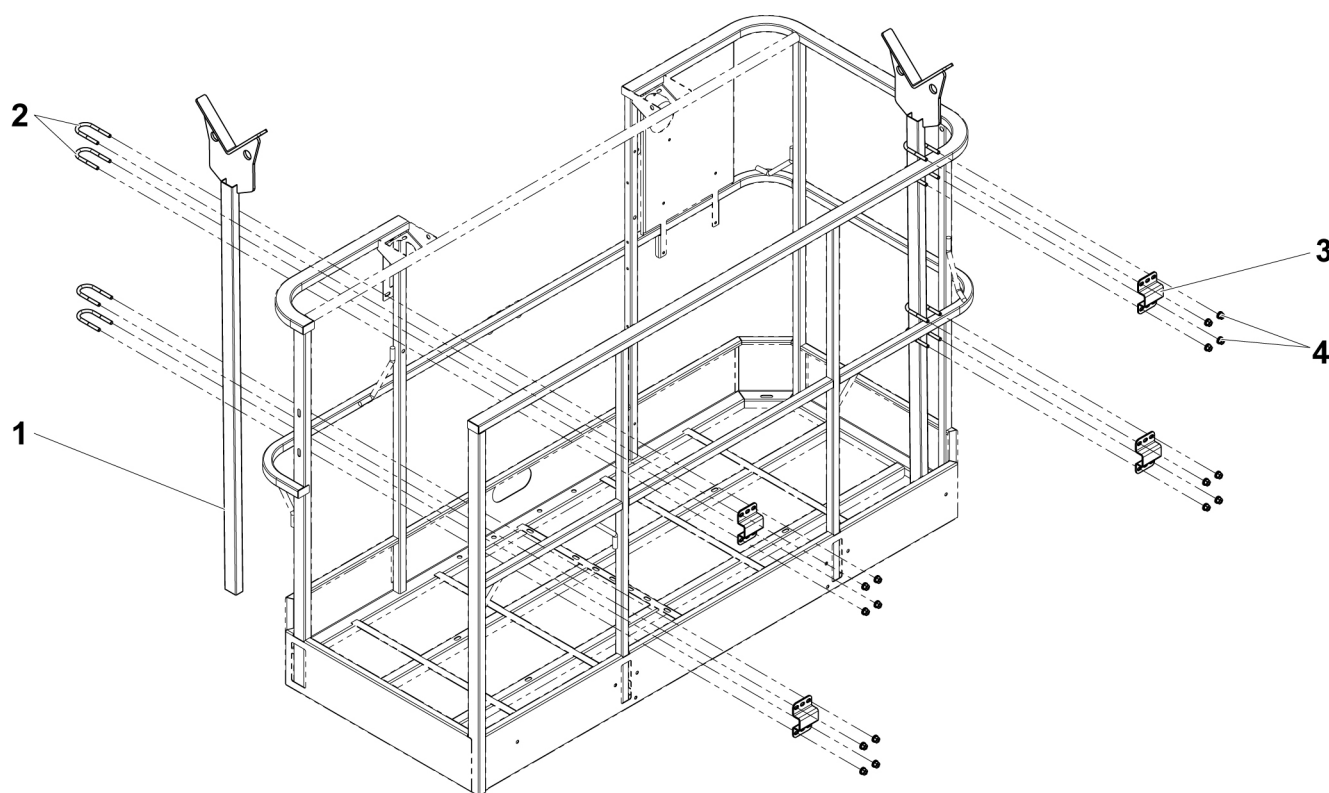

Marking	Description
1	Cradle
2	Fastening screw U bolt
3	Flange
4	Nuts

- Locate the cradles such that the load will be parallel to the length of the platform.
- Install two cradles (1) to the guardrails using 4 supplied flanges (3).

E - General Specifications

- Tighten up the flange using 2 supplied screw U bolts (2) and 4 nuts (4), wherever a cradle and the horizontal guardrail tubes intersect.

N.B.-:TORQUE REQUIREMENTS: 16 NM

- Ensure that the bottom of cradle is resting on the platform floor.
- Ensure that the distance between the 2 cradles support and center the load.
- Pre-operation test: Place and secure the load of 120 kg (265 lbs) on the cradles. Ensure that the cradles can support the load and that there is no visual structural damage.

5.6.7 Specific decals, optional

Location of the decals

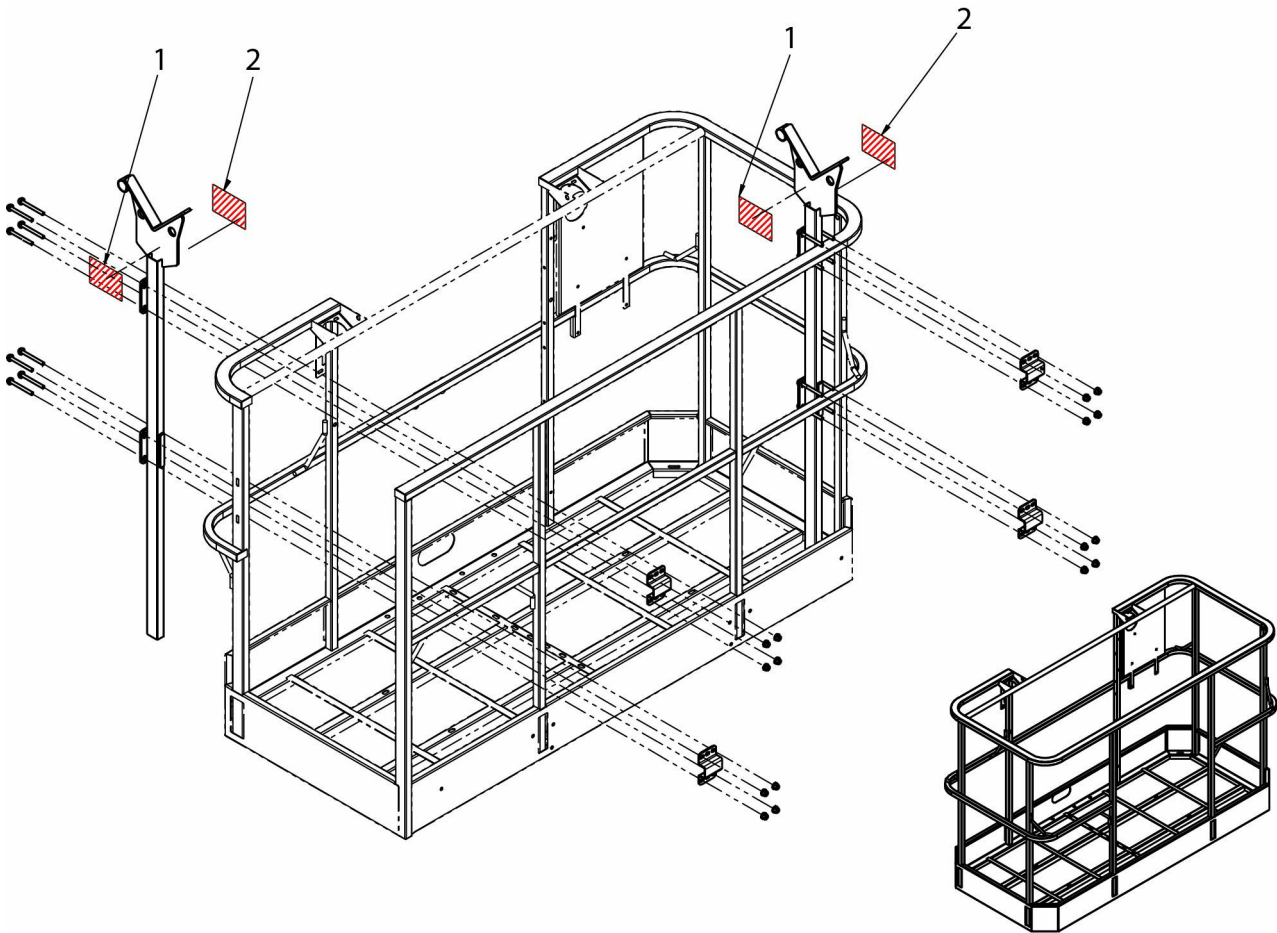

Marking	Description	Quantity	Part number
1	Risk of overturning	2	- In english: 4000131600 - In french: 4000131610 - In spanish: 4000131620 - In german: 4000708570
2	Equipment characteristics	2	4000131650

E - General Specifications

5.7 Activ' Shield Bar - Secondary crush risk reduction system (If fitted)

5.7.1 Description



General Specification Activ' Shield Bar:

- The Activ' Shield Bar system is a device designed to reduce the risk of crushing against the control console when the machine moves, and to notify ground personnel if it is triggered.
- If the Activ' Shield Bar is triggered, all movements are stopped, the horn will sound and the blue light will activate.
- From the platform control console, only movements allowing the user to be freed are possible.
- System status:
 - The green indicator light on the Activ' Shield Bar system is off when the system is inactive or disabled.
 - The green indicator light on the Activ' Shield Bar system flashes when the system is active (machine not moving).
 - The green indicator light on the Activ' Shield Bar system is on when the system is active (machine moving).



- The system does not protect against external collisions when the machine is not moving.
- The system does not reduce the risk of crushing when the speed of movements is excessive and/or not adapted to the environment.



This system does not relieve the operator from the responsibilities of learning and practicing the principles of safe use and operation of the machine as provided by the user manual, employer's safety rules and worksite regulations.

5.7.2 Characteristics

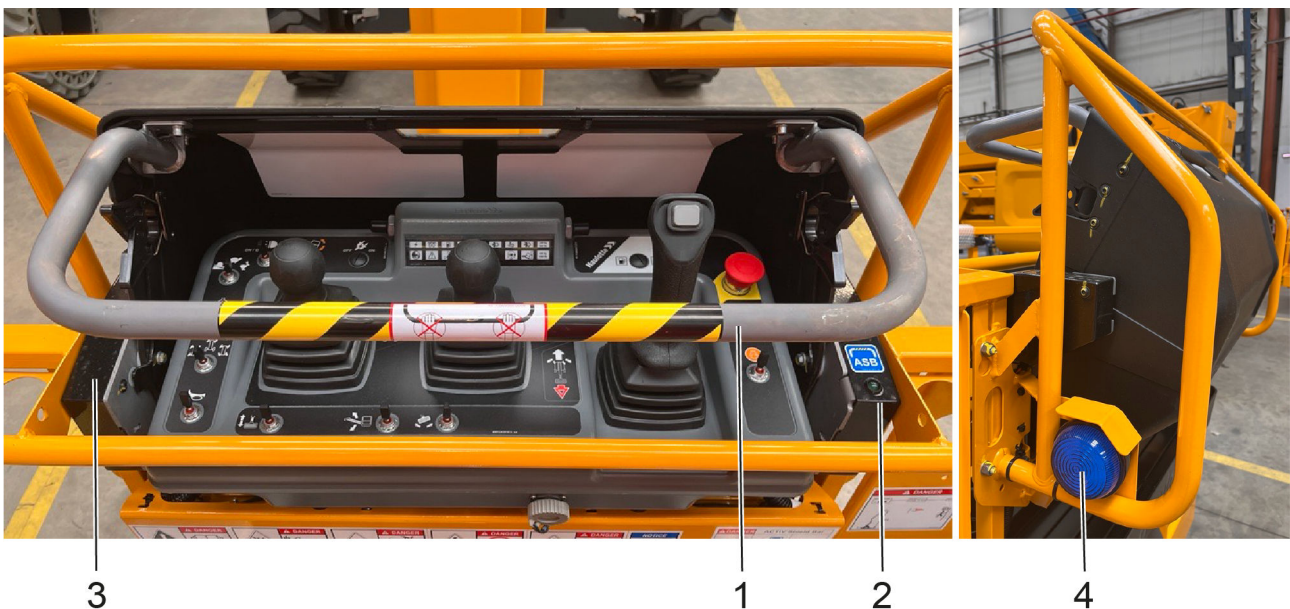

E - General Specifications

Marking	Description
1	Activation bar
2	Green indicator light
3	Sensor
4	Flashing light

5.7.3 Safety precautions



It is mandatory to ensure that the Activ' Shield Bar is functional at each start-up of the machine



Do not use the Activ' Shield Bar as a handhold. This could result in an inadvertent triggering of the Activ' Shield Bar.

- Check the work area for overhead clearances, obstructions or other possible hazards.
- When driving, position the platform so as to provide the best visibility possible and avoid any blind spots.
- Always ensure that the wheels are never driven any closer than 1 m from holes, bumps, tilts, obstructions, debris and ground coverings that may hide dangers.
- During operation, keep all the parts of the body inside the platform.
- To position the machine close to obstacles, you are advised to use the movements of the boom (arm, boom, etc.) instead of the drive movements.
- Do not drive fast in narrow or cluttered areas. Keep speed under control while making turns or sharp bends.

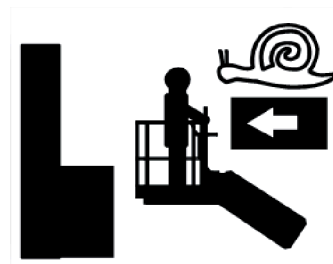
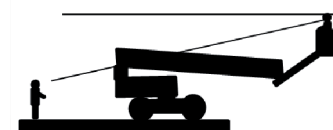

E - General Specifications

5.7.4 Pre-operation inspection



- If any item on the checklist is marked NO during the inspection; machine must be tagged and locked out and placed out of service.
- DO NOT operate the machine until all identified items are corrected and it has been declared safe for operation.

You will need: All machine functional tests to result positive.

Description	Yes	No
To ensure Activ' Shield Bar device is functioning correctly, perform the following:		
Select the upper console.		
Press the activation pedal and check that the green indicator light (2) flashes (machine not moving).		
Perform a movement and check that the green indicator light (2) is on.		
Simultaneously make a movement and push forward the activation bar to trigger the system: <ul style="list-style-type: none"> - Check that all movements are interrupted. - Check that the horn and blue indicator light (4) are working. 		

N.B.:-TO RESET THE ACTIV' SHIELD BAR SYSTEM, RELEASE THE ACTIVATION BAR, THE ACTIVATION PEDAL, THE CONTROLS, AND PRESS THE ACTIVATION PEDAL.

5.7.5 Operation

The Activ' Shield Bar system is triggered by pushing the activation bar. All movements are interrupted, the horn sounds and the blue indicator light comes on. Only movements allowing the user to be freed are possible (all necessary precautions must be taken during these operations to prevent any collision with or entrapment against the structures).

For safety procedures, refer to  D 4 Rescue and Emergency Procedures.

To reset the Activ' Shield Bar system, release the activation bar, the activation pedal, the controls, and press the activation pedal.

5.7.6 Specific decals

Location of the decals

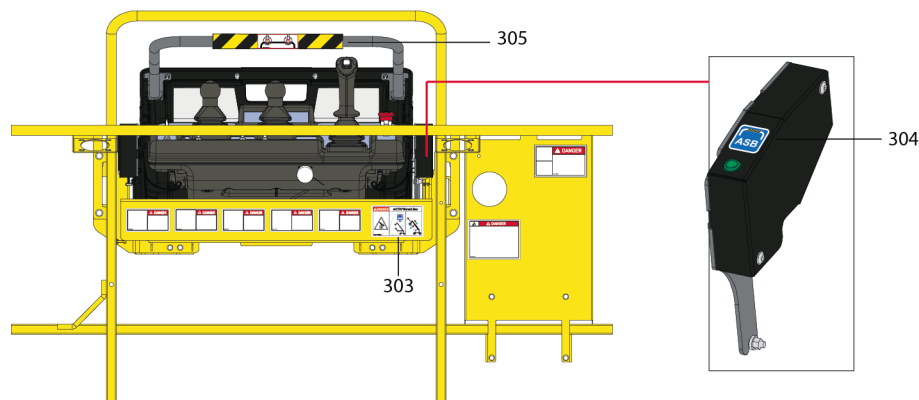

E - General Specifications

Marking	Description	Quantity	Part number
303	Activ' Shield Bar controls	1	4001364690
304	Activ' Shield Bar controls	1	4000596720
305	Do not lean on the bar	1	4000206690

Activ' Shield Bar instructions

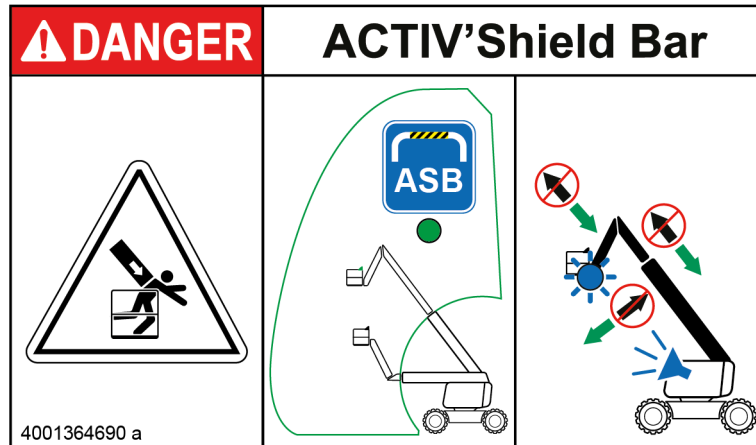

5.8 Sand tires

5.8.1 Technical specifications

Component	Standard wheel
Reference number	33x16LL500
Type-Foam-filled or pneumatic (air-filled)	Foam-filled
Wheel mass	180 kg (396 lbs)
Size	838,2 / 406,4 mm (2 ft 9 in / 1 ft 4 in)
Torque (Wheel nuts / lugs)	320 Nm (236 lbs)

E - General Specifications

5.8.2 Inspection and maintenance

Replace the wheels and the tires if any of the following conditions exist:

- Presence of cracks, damage, deformation or other faults on the hub.
- Damage to the tire:
 - Cut or hole > 3 cm (2 in) in the rubber side wall.
 - Blister or pronounced lump on the external and lateral wall.
 - Damaged wheel stud.
 - Damage or wear on the side wall to the extent that the reinforcing wire is visible.
 - Consistent wear of the ground contact surface greater than 25%.

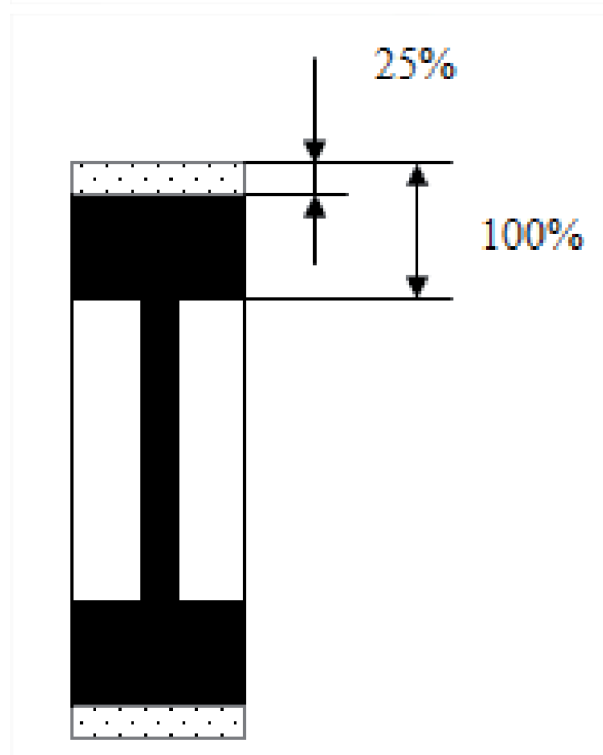
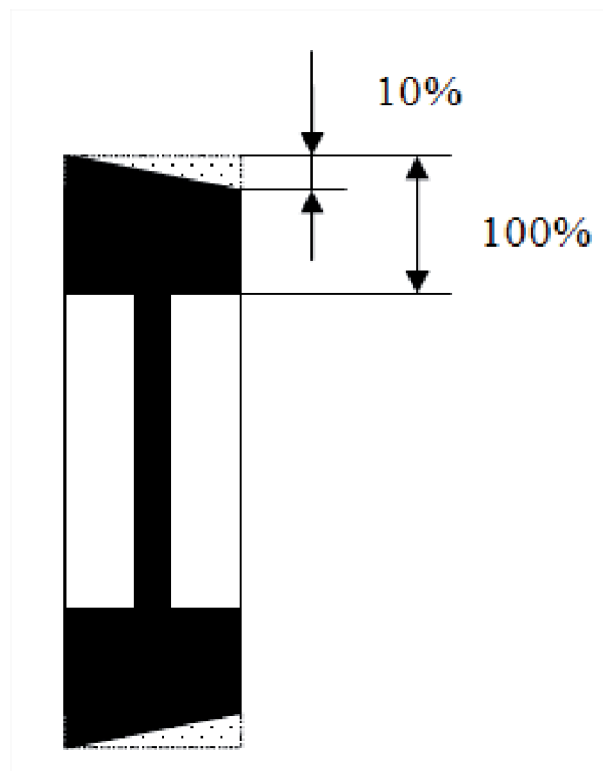

Tires and rims are critical components for the stability of the machine:

- Use only HAULOTTE® spare parts according to the technical characteristics of the machine. Refer to the spare parts catalog.
- Do not replace factory-installed tires with tires of different specifications or ply rating.
- Never replace foam filled tire with a pneumatic (air filled) tire.

E - General Specifications

Procedure of replacement:

- Loosen the wheel nuts on the wheel to be removed.
- Raise the machine using a jack or a hoist.
- Remove the wheel nuts.
- Remove the wheel.
- Install the new wheel.
- Lower the machine to the ground.
- Tighten the wheel nuts to the recommended torque.



F - Maintenance

1	General.....	3
2	Maintenance Schedule.....	4
3	Inspection program.....	5
3.1	General program.....	5
3.2	Daily inspection.....	5
3.3	Periodic inspection.....	5
3.4	Reinforced inspection.....	6
3.5	Major inspection.....	6
4	Repairs and adjustments.....	7

1 General

As an owner and/or operator of Haulotte equipment, your Safety is of utmost importance to HAULOTTE® , which is why HAULOTTE® places such a high priority on product safety.

INSPECTIONS are not only required by HAULOTTE®, but may also be required by industry standards and/or local regulations.

To ensure your equipment continues to achieve the level of performance set in the factory, it is important to maintain it regularly. We remind you that it is strictly forbidden to make any modifications. Regular and timely inspections will reduce equipment down time as well as prevent possible injury.

N.B.-:DO NOT OPERATE UNLESS YOU ARE FAMILIAR AND TRAINED IN THE PRINCIPLES OF SAFE MACHINE OPERATION.

Overview:

- A walk-around inspection of the machine takes only a few minutes at the beginning and end of each shift
— The best way to prevent issues.

What to Do:

- Use your senses: sight, smell, hearing and touch.

Frequency:

- Check your machine periodically during your entire workday.
- Make sure to do your inspection the same way every time.
- Complete one of these inspections at the start and end of each shift.

N.B.-:IF DAMAGE OR UNAUTHORIZED MODIFICATIONS ARE DISCOVERED, THE MACHINE MUST BE REMOVED FROM SERVICE UNTIL REPAIRS ARE MADE BY A QUALIFIED SERVICE TECHNICIAN.

It is the owner's responsibility to ensure the required maintenance as recommended by Haulotte is completed prior to the operation of the machine.

If regular maintenance is not carried out, this may:

- Void the warranty.
- Cause machine malfunction.
- Reduce machine reliability and shorten its service life.
- Jeopardize operator safety.

HAULOTTE Services® technicians are specially trained to carry out extensive repairs, interventions or adjustments on the safety systems or elements of HAULOTTE® machines. They carry genuine HAULOTTE spare parts and tools as required, and also provide fully documented reports on all work completed.

The inspection and maintenance table, identifies the role and the responsibilities of each party in periodical machine maintenance.  C 3 - Inspection and Functional test.

2 Maintenance Schedule

This section provides the necessary information needed to place the machine in safe operation. In accordance with the regulations that are currently applicable, this machine is designed to have a 10 year life span in normal usage conditions. The life may be extended or reduced dependent on the severity of operating conditions, the machine condition itself and by conducting effective inspections and maintenance in addition to other external factors. There are a number of factors which can affect the design life including but not limited to, severity of operating conditions/routine maintenance which should be carried out in accordance with this manual.

Severity of operating conditions may require a reduction in time between maintenance periods. Machines that have been out of service or have not been in use for more than 3 months must undergo a periodic inspection before the machine is put back into service.

Maintenance must be carried out by a competent company or person familiar with mechanical procedures.

Maintenance operations performed must be recorded in a register / log book of the machine.

F - Maintenance

3 Inspection program

3.1 General program

The machine must be inspected on a regular basis at intervals of no less than once 1 per year. The purpose of the inspection is to detect any defect which could lead to an accident during routine use of the machine. Local standards and regulations may require more frequent inspections.

HAULOTTE® requires Reinforced and Major Inspections to be carried out on the product to extend its service life.

Inspections must be carried out by a competent company or person.

The inspection results must be recorded in the safety register or machine log book controlled and overseen by the company manager. This register or machine log book and the list of competent repair persons must be made available to the government work inspector and HAULOTTE Services®.

When	Person-in-charge	Stakeholder	What
Before sale	Owner (or renter)	Competent technician or qualified technician HAULOTTE Service®	Periodic inspection
Before rent	Owner (or renter)	Competent technician or qualified technician HAULOTTE Service®	Daily inspection
Before use or every change of user	Operator	Operator	Daily inspection
Annually (1 year)	Owner (or renter)	Competent technician or qualified technician HAULOTTE Service®	Periodic inspection
5 years	Owner (or renter)	Competent technician or qualified technician HAULOTTE Service®	Reinforced inspection
10 years	Owner (or renter)	Competent technician or qualified technician HAULOTTE Service®	Major inspection

3.2 Daily inspection

The Daily inspection includes a visual inspection, operational checks and testing of the safety systems. This must be conducted by the operator before using the machine.

This inspection is the responsibility of the user. Refer to  C 3.1 - Daily inspection.

3.3 Periodic inspection

The Periodic inspection is a thorough evaluation of the operation and safety features of the machine.

It must be conducted before the sale / resale of the machine and/or at least once every year.

Local regulations may have specific requirements on frequency, and content of inspections.

The severity of operating conditions may require frequent inspections.

This inspection is the responsibility of the owner, and inspections must be carried out by a competent company or person.

This inspection is in addition to the daily inspection.

This inspection should also be conducted after:

- Extensive dismantling and reassembly of major components.
- Repairs involving the machine's essential components.
- Any accident causing stress to the machine.

3.4 Reinforced inspection

The Reinforced inspection is a thorough evaluation of the machine's structural components, to ensure proper functionality of the machine.

This evaluation must occur at a frequency of 5000 hours or every 5 years.

This inspection is the responsibility of the owner, and it must be conducted by a HAULOTTE Services® technician or by a competent company or person.

This inspection includes:

- Daily inspection
- Periodic inspection

N.B.-:REFER TO THE MAINTENANCE MANUAL FOR DETAILS.

3.5 Major inspection

The Major inspection is a thorough evaluation of the machine's integrity and proper functioning; after a normal service life of 10 years.

This evaluation must take place after 10 years of operation and then repeated every 5 years thereafter.

The severity of operating conditions may require frequent inspections.

This inspection is the responsibility of the owner, and it must be conducted by a HAULOTTE Services® technician or by a competent company or person.

This inspection includes:

- Daily inspection
- Periodic inspection
- Reinforced inspection

N.B.-:REFER TO THE MAINTENANCE MANUAL FOR DETAILS.

4 Repairs and adjustments

Extensive repairs, interventions or adjustments on the safety systems or components must be performed by a HAULOTTE Services® technician. Use original spare parts and components only.

N.B.-HAULOTTE SERVICES® TECHNICIANS ARE TRAINED PROFESSIONALS TO PERFORM EXTENSIVE REPAIRS, INTERVENTIONS AND ADJUSTMENTS ON THE SAFETY SYSTEMS OR COMPONENTS OF HAULOTTE® MACHINES. THE TECHNICIAN CARRIES GENUINE HAULOTTE® SPARE PARTS AND TOOLS AS REQUIRED, AND ALSO PROVIDES FULLY DOCUMENTED REPORTS ON ALL WORK COMPLETED.

HAULOTTE Services® will not take responsibility for any outcomes resulting from inferior services or repairs performed by other unauthorised personnel.

HAULOTTE® reminds that NO modifications SHALL be carried out without the written permission of HAULOTTE®.

Any unauthorised repairs/modifications will void HAULOTTE® warranty.

To check for safety campaigns, consult our website: www.haulotte.com



N.B.-WHEN DISPOSING OR SCRAPPING THIS MACHINE, PLEASE CONSIDER APPROPRIATE METHODS OF RECYCLING. ANY ITEMS THAT REQUIRE SPECIFIC DISPOSAL ARE LISTED WITH INSTRUCTIONS IN THE MAINTENANCE MANUAL.

G - Other information

1	Conditions of warranty.....	3
2	Subsidiary contact information.....	4
2.1	California warning.....	5

G - Other information

1 Conditions of warranty

Our warranty conditions and extension contracts are now available on the websites of our sales network: www.haulotte.com







2 Subsidiary contact information

	<p>HAULOTTE FRANCE PARC DES LUMIERES 601 RUE NICEPHORE NIEPCE 69800 SAINT-PRIEST TECHNICAL Department: +33 (0)820 200 089 SPARE PARTS : +33 (0)820 205 344 FAX : +33 (0)4 72 88 01 43 E-mail : haulottefrance@haulotte.com www.haulotte.fr</p>		<p>HAULOTTE ITALIA VIA LOMBARDIA 15 20098 SAN GIULIANO MILANESE (MI) TEL: +39 02 98 97 01 FAX: +39 02 9897 01 25 E-mail : haulotteitalia@haulotte.com www.haulotte.it</p>		<p>HAULOTTE INDIA Unit No. 1205, 12th floor, Bhumiraj Costarica, Plot No. 1&2, Sector 18, Palm Beach Road, Sanpada, Navi Mumbai- 400 705 Maharashtra, INDIA Tel. : +91 22 66739531 to 35 E-mail : hlindia@haulotte.com www.haulotte.in</p>
	<p>HAULOTTE HUBARBEITSBÜHNEN GmbH Ehrenkirchener Strasse 2 D-79427 ESCHBACH TEL : +49 (0) 7634 50 67 - 0 FAX : +49 (0) 7634 50 67 - 119 E-mail : adv-gmbh@haulotte.com www.haulotte.de</p>		<p>HAULOTTE AUSTRALIA PTY Ltd 51 Port Link Drive DANDENONG - VIC - 3175 TEL : 1 300 207 683 FAX : +61 (0)3 9792 1011 E-mail : sales@haulotte.com.au www.haulotte.com.au</p>		<p>HAULOTTE DO BRASIL Av. Alameda Caiapós, 589 CEP: 06460-110 - TAMBORE BARUERI - SAO PAULO - BRASIL TEL : +55 11 4196 4300 FAX : +55 11 4196 4316 E-mail : haulottebrasil@haulotte.com www.haulotte.com.br</p>
	<p>HAULOTTE IBERICA C/ARGENTINA Nº 13 - P.I. LA GARENA 28806 ALCALA DE HENARES MADRID TEL : +34 902 886 455 TEL SAT : +34 902 886 444 FAX : +34 911 341 844 E-mail : iberica@haulotte.com www.haulotte.es</p>		<p>HAULOTTE POLSKA Sp. Z.o.o. UL. GRANICZNA 22 05-090 RASZYN - JANKI TEL : +48 22 720 08 80 FAX : +48 22 720 35 06 E-mail : haulottepolska@haulotte.com www.haulotte.pl</p>		<p>HAULOTTE MÉXICO, S.A. de C.V. Calle 40 SUR ESQUINA 13 ESTE No. S/N Colonia CIVAC, JUITEPEC, MORELOS CP 62578 México TEL : +52 77 7321 7923 FAX : +52 77 7516 8234 E-mail : haulotte.mexico@haulotte.com www.haulotte.com.mx</p>
	<p>HAULOTTE in JAPAN SBJ ShinOsaka BLDG 3F 4-6-5 Nishinakajima Yodogawa-ku, Osaka, JAPAN, Post Code: 532-0011 TEL : +81 6 6795 9008 FAX : +81 6 6795 9009 www.haulotte.com</p>		<p>HAULOTTE SINGAPORE Pte Ltd. No.26 CHANGI NORTH WAY, SINGAPORE 498812 Parts and service Hotline: +65 6546 6150 FAX : +65 6536 3969 E-mail : haulotteasia@haulotte.com www.haulotte.sg</p>		<p>HAULOTTE MIDDLE EAST FZE PO BOX 293881 Dubai Airport Free Zone DUBAI United Arab Emirates TEL : +971 (0)4 299 77 35 FAX : +971 (0) 4 299 60 28 E-mail : haulottemiddle-east@haulotte.com www.haulotte.ae</p>
	<p>HAULOTTE SCANDINAVIA AB Taljegårdsgatan 12 431 53 Mölndal SWEDEN TEL : +46 31 744 32 90 FAX : +46 31 744 32 99 E-mail : info@se.haulotte.com spares@se.haulotte.com www.haulotte.se</p>		<p>HAULOTTE TRADING (SHANGHAI) Co. Ltd. Room 606A, Tower 3, Ronshine Sunkwan Center Lane 77, Sunkun Road MINHANG DISTRICT SHANGHAI 201105 CHINA TEL : +86 21 6442 6607 FAX : +86 21 6442 6619 E-mail : haulotteshanghai@haulotte.com www.haulotte.cn</p>		<p>HAULOTTE ARGENTINA Ruta Panamericana Km. 34,300 (Ramal A Escobar) 1615 Gran Bourg (Provincia de Buenos Aires) Argentina TEL : +54 33 27 445991 FAX : +54 33 27 452191 E-mail : haulotteargentina@haulotte.com www.haulotte.com.ar</p>
	<p>HAULOTTE UK Ltd 1 Gravely Way Four Ashes Wolverhampton WV10 7GW ENGLAND TEL : +44 (0)1216 199753 FAX : +44 (0)1952 292758 E-mail : salesuk@haulotte.com www.haulotte.co.uk</p>		<p>HAULOTTE GROUP / BILJAX 125 TAYLOR PARKWAY ARCHBOLD, OH 43502 - USA TEL : +1 419 445 8915 FAX : +1 419 445 0367 Toll free : +1 800 537 0540 E-mail : sales@us.haulotte.com www.haulotte-usa.com</p>		<p>HAULOTTE NORTH AMERICA 3409 Chandler Creek Rd. VIRGINIA BEACH, VA 23453 - USA TEL : +1 757 689 2146 FAX : +1 757 689 2175 Toll free : +1 800 537 0540 E-mail : sales@us.haulotte.com www.haulotte-usa.com</p>
	<p>HAULOTTE NETHERLANDS BV Koopvaardijweg 26 4906 CV OOSTERHOUT - Nederland TEL : +31 (0) 162 670 707 FAX : +31 (0) 162 670 710 E-mail info@haulotte.nl www.haulotte.nl</p>				<p>HAULOTTE CHILE Panamerica Norte Altura Km 21,5 Colina (Cruce c/Lo Pinto) Santiago (RM) TEL : + 562 2 3727630 E-mail : haulotte-chile@haulotte.com www.haulotte-chile.com</p>

G - Other information

2.1 California warning

For the US destined machines (ANSI and CSA standards)

<p>CALIFORNIA</p>  <p>Proposition 65 Warning</p> <p>Operating, servicing and maintaining a passenger vehicle or off-road vehicle can expose you to chemicals including engine exhaust, carbon monoxide, phthalates, and lead, which are known to the State of California to cause cancer and birth defects or other reproductive harm. To minimize exposure, avoid breathing exhaust, do not idle the engine except as necessary, service your vehicle in a well-ventilated area and wear gloves or wash your hands frequently when servicing your vehicle.</p> <p>For more information go to  www.P65Warnings.ca.gov/passenger-vehicle</p>
<p>CALIFORNIE</p>  <p>Avertissement de la Proposition 65</p> <p>L'exploitation, l'entretien et la maintenance d'un véhicule de tourisme ou d'un véhicule tout-terrain peuvent vous exposer à des produits chimiques, y compris les gaz d'échappement, le monoxyde de carbone, les phthalates et le plomb, identifiés par l'État de Californie comme pouvant causer le cancer et des malformations congénitales ou autres effets nocifs sur la reproduction. Pour limiter toute exposition: évitez de respirer les gaz d'échappement, ne laissez pas tourner le moteur au ralenti sauf si nécessaire, faites l'entretien du véhicule dans une zone bien aérée et portez des gants ou lavez vous fréquemment les mains lors de cette opération.</p> <p>Pour de plus amples informations, consulter  www.P65Warnings.ca.gov/passenger-vehicle</p>
<p>CALIFORNIA</p>  <p>Advertencia de la Proposición 65</p> <p>Operar, dar servicio y mantenimiento a un vehículo de pasajeros o vehículo todo terreno puede exponerle a químicos incluyendo gases del escape, monóxido de carbono, ftalatos y plomo, los cuales son conocidos por el Estado de California como causantes de cáncer y defectos de nacimiento u otros daños reproductivos. Para minimizar la exposición, evite respirar los gases del escape, no encienda el motor excepto si es necesario, dé servicio a su vehículo en un área bien ventilada y utilice guantes o lave sus manos frecuentemente cuando dé servicio a su vehículo.</p> <p>Para mayor información visite  www.P65Warnings.ca.gov/passenger-vehicle</p>

G - Other information

For the engine powered machines destined to the US market (Standards ANSI and CSA)

CALIFORNIA



Proposition 65 Warning

Breathing diesel engine exhaust exposes you to chemicals known to the State of California to cause cancer and birth defects or other reproductive harm.

- ✓ Always start and operate the engine in a well-ventilated area.
- ✓ If in an enclosed area, vent the exhaust to the outside.
- ✓ Do not modify or tamper with the exhaust system.
- ✓ Do not idle the engine except as necessary.

For more information go to  www.P65Warnings.ca.gov/diesel

CALIFORNIE



Avertissement de la Proposition 65

Respirer les gaz d'échappement de moteurs diesel peut vous exposer à des agents chimiques identifiés par l'État de Californie comme pouvant causer le cancer et des malformations congénitales ou autres effets nocifs sur la reproduction.

- ✓ Toujours démarrer et faire tourner le moteur dans une zone bien aérée.
- ✓ Si la zone est mal ventilée, évacuer les gaz d'échappement à l'extérieur.
- ✓ Ne pas modifier ou altérer le système d'échappement.
- ✓ Ne laisser le moteur tourner au ralenti que si cela est nécessaire.

Pour de plus amples informations, consulter  www.P65Warnings.ca.gov/diesel

CALIFORNIA



Advertencia de la Proposición 65

Respirar los gases del escape de motores a diésel le expone a químicos conocidos por el Estado de California como causantes de cáncer y defectos de nacimiento u otros daños reproductivos.

- ✓ Siempre encienda y opere el motor en un área bien ventilada.
- ✓ Si es en un área cerrada, ventile el orificio del escape hacia el exterior.
- ✓ Ne pas modifier ou altérer le système d'échappement.
- ✓ No modifique ni altere el sistema de escape.

Para mayor información visite  www.P65Warnings.ca.gov/diesel

H - Records

1 Intervention register..... 3

1 Intervention register

The intervention register keeps a record of maintenance and repair work carried out inside or outside the maintenance programme.

N.B.:-IN THE CASE OF A HAULOTTE SERVICES® INTERVENTION, THE QUALIFIED TECHNICIAN MUST INDICATE THE HAULOTTE SERVICES® INTERVENTION NUMBER.

Date	Type of intervention	Number of hours	Intervenor	Intervention number

