

Operation & Maintenance Manual

Self-Propelled
Articulating Boom Lifts

GTBZ16AE
GTBZ18AE



Dingli
Machinery

Part Number: SM0414111 Second Edition

Version of the Record

Version Number	Create Date	Founder	Audit
SM0414111_Rev1.0	October 2014	Haohao Zhang	
SM0414111_Rev2.0	April 2015	Haohao Zhang	

Table of Contents

Foreword	1
Section 1 Safety Precaution	
1.1 General.....	1-1
1.2 Safety Alert Symbols and Safety Signal Words	1-1
1.3 Safety Precaution	1-2
1.3.1 Operator Training and Knowledge	1-2
1.3.2 Workplace Inspection.....	1-2
1.3.3 Machine Inspection.....	1-3
1.4 Operation.....	1-3
1.4.1 General.....	1-3
1.4.2 Trip and Fall Hazards	1-4
1.4.3 Electrocuting Hazards	1-5
1.4.4 Tipping Hazards	1-6
1.4.5 Crushing and Collision Hazards	1-7
1.5 Towing, Lifting and Hauling	1-8
1.6 Additional Hazards / Safety	1-9
Section 2 Specification	
2.1 Machine Specification	2-1
2.1.1 GTBZ16AE Machine Specification	2-1
2.1.2 GTBZ18AE Machine Specification	2-2
2.2 Performance Specification	2-3
2.3 Hydraulic System Specification	2-4
2.4 Battery Specification	2-5
2.5 Bolt Torque Specification.....	2-6
Section 3 User responsibility, Machine Preparation and Inspection	
3.1 Personnel Training	3-1
3.1.1 Operator Training	3-1
3.1.2 Training Supervision	3-1
3.1.3 Operator Responsibility.....	3-1
3.2 Preparation, Inspection and Maintenance	3-2
3.2.1 General.....	3-2
3.2.2 Preparation for Use.....	3-2

3.2.3 Delivery and Frequent Inspection.....	3-3
3.2.4 Daily Walk-around Inspection.....	3-5
3.2.5 Daily Function Check.....	3-9
Section 4 Machine Controls and Indicators	
4.1 General.....	4-1
4.2 Controls and Indicators	4-1
4.2.1 Ground Control Station.....	4-1
4.2.2 Platform Control Station	4-6
4.2.3 The Multi-Function Gauge	4-11
4.2.4 The Control Unit Display Panel	4-12
4.3 Tilt Alarm Warning.....	4-13
4.4 Footswitch/Enable Indicator	4-14
4.5 Placards and Decals	4-15
Section 5 Operation Instruction	
5.1 Description.....	5-1
5.2 Operating Characteristics and Limitations	5-2
5.3 Traveling (Driving) Operation	5-5
5.4 Steering Operation.....	5-5
5.5 Platform Operation.....	5-6
5.6 Turntable Swinging Operation	5-6
5.7 Boom Operation.....	5-7
5.8 Auxiliary Pump Operation.....	5-9
5.9 Shut Down and Parking	5-9
5.10 Lifting and Tie Down	5-9
5.11 Towing Operation	5-11
Section 6 Emergency Procedures	
6.1 General.....	6-1
6.2 Emergency Towing Procedures	6-1
6.3 Emergency Controls and Their Locations.....	6-2
6.3.1 Power/Emergency Stop Switches	6-2
6.3.2 Ground Control Station	6-2
6.3.3 Auxiliary hand pump	6-2
6.4 Emergency Operation.....	6-3
6.4.1 Use of Ground Controls	6-3
6.4.2 Operator Unable to Control Machine.....	6-3

6.4.3 Platform or Boom Caught Overhead 6-3
6.4.4 Post Incident Inspection and Repair 6-3
6.4.5 Manual Swing Override 6-3
6.5 Incident Notification..... 6-4

Section 7 General Maintenance

7.1 General..... 7-1
7.2 Lubrication Specification 7-1
7.3 Lubrication Diagram..... 7-1
7.4 Operator Maintenance 7-3
 7.4.1 Wheel Bearings 7-3
 7.4.2 Lubrication for the Swing Bearing and Worm Gear..... 7-3
 7.4.3 Test and Replace the Hydraulic Oil..... 7-4
 7.4.4 Replace the Hydraulic Filters 7-6
 7.4.5 Tires & Wheels Maintenance..... 7-7
 7.4.6 Battery Maintenance 7-9

Section 8 Schematics

8.1 General..... 8-1
8.2 Troubleshooting 8-1
8.3 Hydraulic Circuit Checks 8-1
 8.3.1 Hydraulic Schematics..... 8-2
 8.3.2 Electric Schematics..... 8-3

Section 9 Inspection and Repair Log

9.1 Inspection and Repair Log 9-1

Foreword

We are very appreciated for your interesting with Dingli machine and choosing it for your application. Our priority above all is you can use the machine safely for your application and you can benefit from the Dingli machine mostly. For these reason we hope you can:

1. Comply with employer, job site and local governmental rules.
2. The manual provides very important information about the machine. It is essential to the owner or the operator who use the machine. So we strongly recommend that you should read the manual thoroughly before attempting to do anything with the machine, so as to understand and follow the instruction or other information in the manual, especially the safety information.
3. Dingli cannot anticipate every possible circumstance that might involve a potential hazard. The warnings in this publication and on the product are, therefore, not all inclusive. If a tool, procedure, work method or operating technique that is not specifically recommended by Dingli is used, you must satisfy yourself that it is safe for you and for others. You should also ensure that the product will not be damaged or be made unsafe by the operation, lubrication, maintenance or repair procedure that you choose.
4. The information, specifications, and illustrations in this publication are on the basis of information that was available at the time that the publication was written. Due to the continuous improvements, Dingli reserve the rights to make the specifications changes without prior notification. Please contact with Dingli dealers or Dingli distributors to obtain the complete and most current information.
5. Any one who read the manual or used the machine, is encouraged to notify Dingli Machinery Co, Ltd of any errors or send in suggestions for improvement. All communications will be carefully considered for future printings of this and other manuals, certainly if you have any question about the machine, please contact with our team by dialing technical support phone, sending email, or any methods you want, etc. Our contact information as bellow:

If you are in China Mainland, Please contact with:

Zhejiang Dingli Machinery Co.,Ltd. Domestic Office:

Phone: +86 572 8681685

Fax: +86 572 8681687

Email: sales@cndingli.com

If you are out of the China Mainland, Please contact with:

Zhejiang Dingli Machinery Co.,Ltd. International Office:

Phone: +86 572 8681688

Fax: +86 572 8681690

Email: export@cndingli.com

Safety Precaution

Section 1

1.1 General

This section prescribes the proper and safe practices for major areas of machine usage. In order to promote proper usage of the machine, it is mandatory that a daily routine be established based on instructions given in this section. A maintenance program must also be established by a qualified person and must be followed to ensure that the machine is safe to operate.

The owner/user/operator of the machine should not accept operating responsibility until this manual has been read and understood, and operation of the machine, under the supervision of an experienced and qualified person, has been completed. If there is a question on application and/or operation, Dingli Machinery Co.,Ltd. should be consulted.

Most accidents that involve product operation, maintenance and repair are caused by failure to observe basic safety rules or precautions. An accident can often be avoided by recognizing potentially hazardous situations before an accident occurs. A person must be alerted to potential hazards. This person should also have the necessary training, skills, and tools to perform these functions properly.

Improper operation, lubrication, maintenance or repair of this product can be dangerous and could result in injury or death. Do not operate or perform any lubrication, maintenance or repair on this product, until you have read and understood the operation, lubrication, and maintenance & repair information.

1.2 Safety Alert Symbols and Safety Signal Words



This Safety Alert Symbol is used to call attention to POTENTIAL HAZARDS, if these hazard warnings are not heeded, bodily injury or death could occur to you or to other persons. The hazards are identified by the "Safety Alert Symbol" and followed by a "Signal Word" such as DANGER, WARNING" or CAUTION, which have been inserted throughout this manual to emphasize these areas. They are defined as follows:

! DANGER

Indicate an IMMEDIATELY HAZARDOUS SITUATION, which if not avoided, WILL RESULT IN SERIOUS INJURY or DEATH. This decal will have a red background

⚠ WARNING

Indicate a potentially HAZARDOUS SITUATION, which if not been avoided, Could RESULT IN SERIOUS INJURY OR DEATH. This decal will have an orange background.

⚠ CAUTION

Indicate a potentially HAZARDOUS SITUATION, which if not avoided, may RESULT IN minor or moderate INJURY. This decal will have a yellow background.

NOTICE

Indicate a potentially hazardous situation, which if not avoided, could result in property damage, this decal have a blue background.

1.3 Safety Precaution

⚠ WARNING

FAILURE TO COMPLY WITH THE SAFETY PRECAUTIONS LISTED IN THIS MANUAL COULD RESULT IN MACHINE DAMAGE, PROPERTY DAMAGE, PERSONAL INJURY OR DEATH.



1.3.1 Operator Training and Knowledge

- Read and understand this manual before operating the machine.
- Read, understand, and obey all **DANGERS, WARNINGS, CAUTIONS**, and operating instructions on the machine and in this manual.
- Do not operate this machine until complete training is performed by authorized persons. Only authorized and qualified personnel can operate the machine.
- Use the machine in a manner which is within the scope of its intended application.
- All operating personnel must be familiar with the emergency controls and emergency operation of the machine as specified in this manual.
- Read, understand, and obey all applicable employer, local, and governmental regulations as they pertain to operation of the machine.

1.3.2 Workplace Inspection

- The operator is to take safety measures to avoid all hazards in the work area prior to machine operation.
- Do not operate or raise the platform while on trucks, trailers, railway cars, floating vessels, scaffolds or other equipment.

- Do not operate the machine in hazardous environments unless approved for that purpose by Dingli.
- Be sure that the ground conditions are able to support the maximum load shown on the decals located on the machine.
- This machine can be operated in temperatures of -20°C to 40°C. Consult Dingli for operation outside this range.

1.3.3 Machine Inspection

- Before machine operation, perform inspections and functional checks. Refer to **Section 3** of this manual for detailed instructions.
- Do not operate this machine until it has been serviced and maintained according to requirements specified by the manufacture.
- Be sure the footswitch and all other safety devices are operating properly. Modification of these devices is a safety violation.

⚠ WARNING

MODIFICATION OR ALTERATION OF AN AERIAL WORK PLATFORM SHALL BE MADE ONLY WITH WRITTEN PERMISSION FROM THE MANUFACTURER.

- Do not operate any machine on which safety or instruction placards or decals are missing or illegible.
- Avoid any buildup of debris on the platform floor. Keep mud, oil, grease, and other slippery substances from footwear and platform floor.



1.4 Operation

1.4.1 General

- Do not use the machine for any purpose other than positioning personnel, their tools, and equipment.
- Never operate a machine that is not working properly. If a malfunction occurs, shut down the machine for troubleshooting.
- Never slam a control switch or lever through neutral to an opposite direction. Always return switch to neutral and stop before moving the switch to the next function. Operate controls with slow and even pressure. Hydraulic cylinders should never be left fully extended or fully retracted before shutdown or for long periods of time.
- Do not allow personnel to tamper with or operate the machine from the ground with personnel in the platform, except in an emergency.
- Do not carry materials directly on platform railing.

- When two or more persons are in the platform, the operator shall be responsible for all machine operations.
- Always ensure that power tools are properly stowed and never left hanging by their cord from the platform work area.
- Supplies or tools which extend outside the platform are prohibited unless approved.
- When driving, always position boom over rear axle in line with the direction of travel. Remember, if boom is over the front axle, steer and drive functions will be reversed.
- Do not assist a stuck or disabled machine by pushing, pulling, or by using boom functions. Only pull the unit from the tie-down lugs on the chassis.
- Do not place boom or platform against any structure to steady the platform or to support the structure.
- Stow boom and shut off all power before leaving machine.

1.4.2 Trip and Fall Hazards

- During operation, occupants in the platform must wear a full body harness with a lanyard attached to an authorized lanyard anchorage point. Attach only one (1) lanyard per lanyard anchorage point.
- Before operating the machine, make sure all gates are closed and fastened in their proper position.

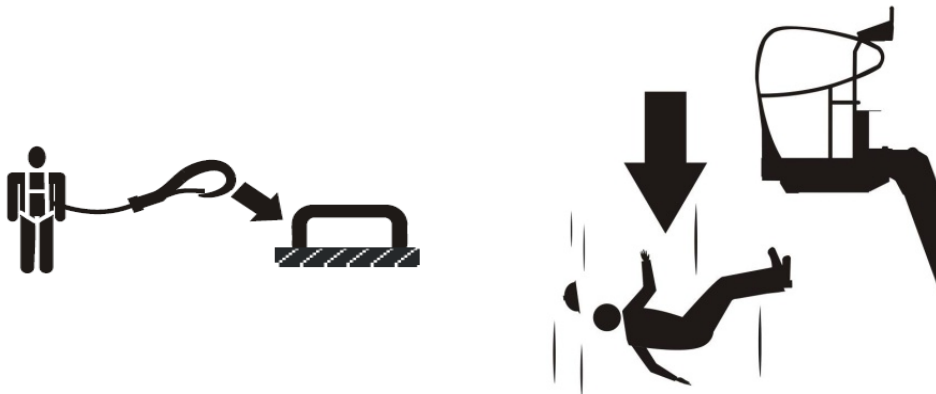

- Keep both feet firmly positioned on the platform floor at all times. Never use ladders, boxes, steps, planks, or similar items on platform to provide additional reach.

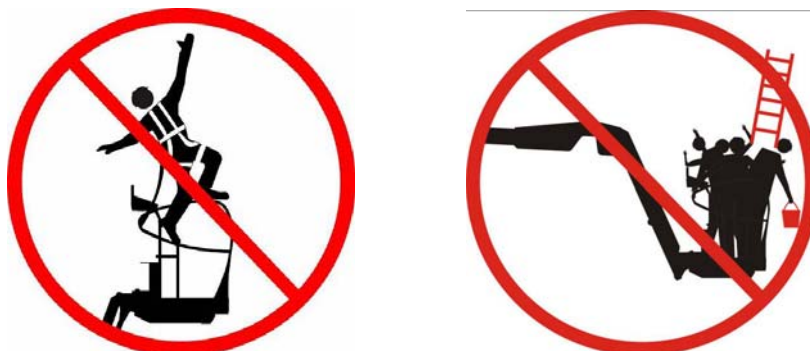

- Never use the boom assembly to enter or leave the platform.
- Use extreme caution when entering or leaving platform. Be sure that the boom is fully lowered. It may be necessary to telescope out to position the platform closer to the ground for entry/exit. Face the machine, maintain “three point contact” with the machine, using two hands and one foot or two feet and one hand during entry and exit.

1.4.3 Electrocuting Hazards

- This machine is not insulated and does not provide protection from contact or proximity to electrical current.

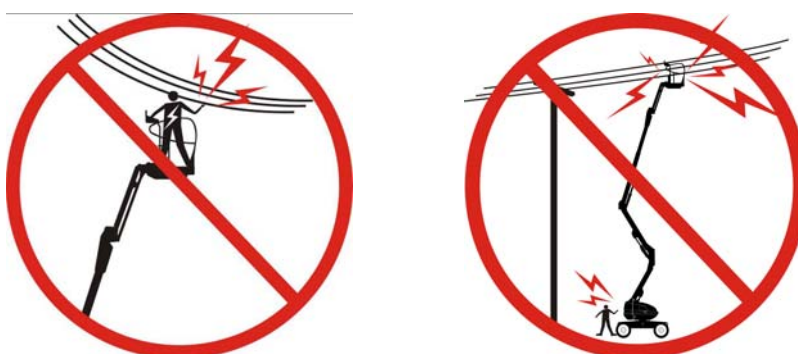

- Maintain distance from electrical lines, apparatus, or any energized (exposed or insulated) parts according to the Minimum Approach Distance (MAD) as shown in Table 1.1

Table 1-1. Minimum Approach Distances (M.A.D.)

Voltage Range (Phase to Phase)	MINIMUM APPROACH DISTANCE in Feet (Meters)
0 to 50 KV	10 (3)
Over 50KV to 200 KV	15 (5)
Over 200 KV to 350 KV	20 (6)
Over 350 KV to 500 KV	25 (8)
Over 500 KV to 750 KV	35 (11)
Over 750 KV to 1000 KV	45 (14)

NOTE: This requirement shall apply except where employer, local or governmental regulations are more stringent.

- Allow for machine movement and electrical line swaying.
- Maintain a clearance of at least 10 ft. (3m) between any part of the machine and its occupants, their tools, and their equipment from any electrical line or apparatus carrying up to 50,000 volts. One foot additional clearance is required for every additional 30,000 volts or less.
- The minimum approach distance may be reduced if insulating barriers are installed to prevent contact, and the barriers are rated for the voltage of the line being guarded. These barriers shall not be part of (or attached to) the machine. The minimum approach distance shall be reduced to a distance within the designed working dimensions of the insulating barrier. This

determination shall be made by a qualified person in accordance with the employer, local, or governmental requirements for work practices near energized equipment.

⚠ DANGER

DO NOT MANEUVER MACHINE OR PERSONNEL INSIDE PROHIBITED ZONE (MAD). ASSUME ALL ELECTRICAL PARTS AND WIRING IS ENERGIZED UNLESS KNOWN OTHERWISE.

1.4.4 Tipping Hazards

- The user should be familiar with the surface before driving. Do not exceed the allowable side slope and grade while driving.
- Do not elevate platform or drive with platform elevated while on a sloping, uneven, or soft surface.
- Before driving on floors, bridges, trucks, and other surfaces, check allowable capacity of the surfaces.

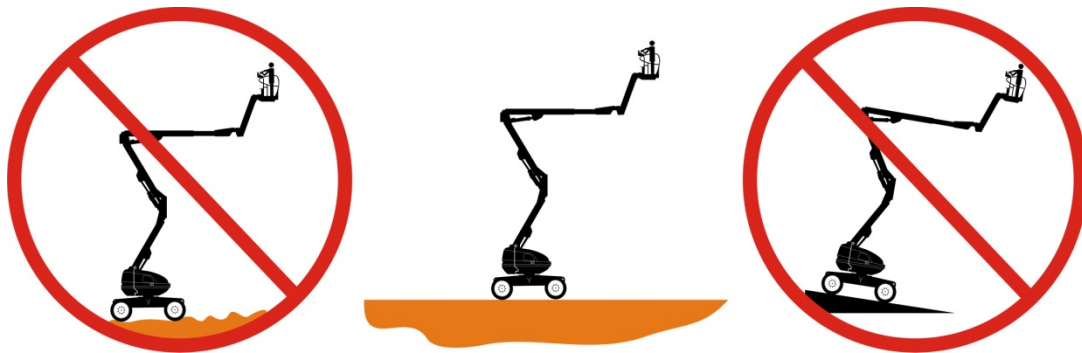

- Never exceed the maximum platform capacity. Distribute loads evenly on platform floor.

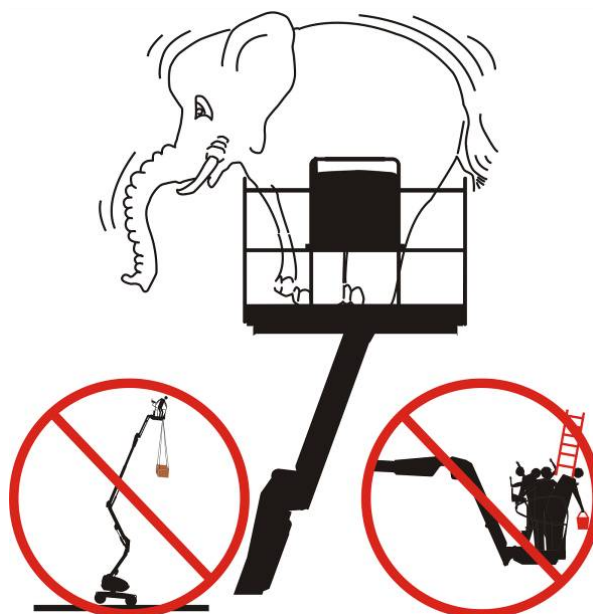

- Do not raise the platform or drive from an elevated position unless the machine is on firm,

level and smooth surfaces.

- Keep the chassis of the machine at least 2 ft. (0.6m) from holes, bumps, drop-offs, obstructions, debris, concealed holes, and other potential hazards on the floor/surface.
- Do not push or pull any object with the boom.
- Never attempt to use the machine as a crane.
- Do not tie off machine to any adjacent structure.
- Do not operate the machine when wind conditions exceed 28 mph (12.5 m/s).



- Do not increase the platform size with unauthorized deck extensions or attachments.
- If boom assembly or platform is in a position that one or more wheels are off the ground, all persons must be removed before attempting to stabilize the machine. Use cranes, forklift trucks, or other appropriate equipment to stabilize machine and remove personnel.

1.4.5 Crushing and Collision Hazards

- Approved head gear must be worn by all operating and ground personnel.
- Check work area for clearances overhead, on sides, and bottom of platform when lifting or lowering platform, and driving.



- During operation, keep all body parts inside platform railing.
- Use the boom functions, not the drive function, to position the platform close to obstacles.
- Always post a lookout when driving in areas where vision is obstructed.
- Keep non-operating personnel at least 6 ft. (1.8m) away from machine during all driving and swing operations.

- Limit travel speed according to conditions of ground surface, congestion, visibility, slope, location of personnel, and other factors which may cause collision or injury to personnel.
- Be aware of stopping distances in all drive speeds. When driving in high speed, switch to low speed before stopping. Travel grades in low speed only.
- Do not use high speed drive in restricted or close quarters or when driving in reverse.



- Exercise extreme caution at all times to prevent obstacles from striking or interfering with operating controls and persons in the platform.
- Be sure that operators of other overhead and floor level machines are aware of the aerial work platform's presence. Disconnect power to overhead cranes.
- Warn personnel not to work, stand, or walk under a raised boom or platform. Position barricades on floor if necessary.

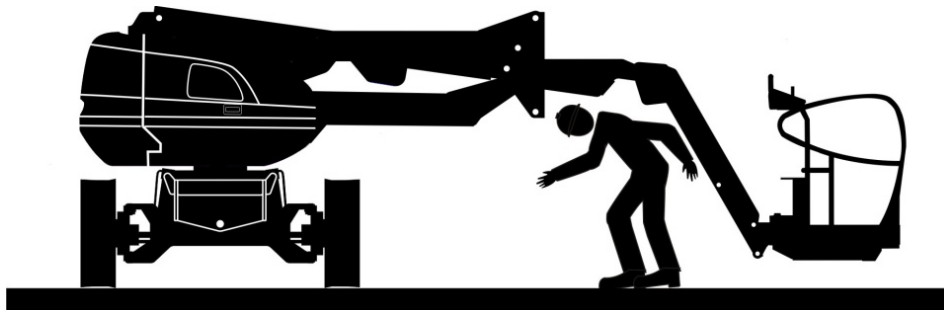

1.5 Towing, Lifting and Hauling

- Never allow personnel in platform while towing, lifting, or hauling.
- This machine should not be towed, except in the event of emergency, malfunction, power failure, or loading/unloading. Refer to the Emergency Procedures section of this manual for emergency towing procedures.
- Ensure boom is in the stowed position and the turntable locked prior to towing, lifting or hauling. The platform must be completely empty of tools.
- When lifting machine, lift only at designated areas of the machine. Lift the unit with equipment of adequate capacity.
- Refer to the Machine Operation section of this manual for lifting information.

1.6 Additional Hazards / Safety

- Do not use machine as a ground for welding.
- When performing welding or metal cutting operations, precautions must be taken to protect the chassis from direct exposure to weld and metal cutting spatter.
- Battery fluid is highly corrosive. Avoid contact with skin and clothing at all times.
- Charge batteries only in a well ventilated area.

Specification

Section 2

2.1 Machine Specification

2.1.1 GTBZ16AE Machine Specification

Stowed Dimension	
Length(transport position)	6.77m
Overall Length	6.77m
Overall Width	1.73m
Overall Height	1.99m
Machine Gross Weight	6700kg
Ground Clearance	0.20m
Operation Dimension	
Maximum Platform Height	14.3m
Maximum Working Height	16.3m
Maximum Up and Over Height	7.89m
Maximum Horizontal Reach	7.15m
Main Boom Up Angle	75°
Main Boom Down Angle	-8°
Maximum Turntable Tail swing	0
Wheelbase	2.0m
Minimum Turning Circle Inside	2.08m
Minimum Turning Circle Outside	3.30m
Turntable Rotation	±180°
Platform Rotation	±90°
Jib Up/Down Angle	+70° /-60°
Tire and Wheels	

Foam Filled Tire	
Size	17.5*6.75
Outer Diameter	700mm
Width	220mm

2.1.2 GTBZ18AE Machine Specification

Stowed Dimension	
Length(transport position)	7.21m
Overall Length	7.21m
Overall Width	1.73m
Overall Height	1.99m
Machine Gross Weight	7300kg
Ground Clearance	0.20m
Operation Dimension	
Maximum Platform Height	16m
Maximum Working Height	18m
Maximum Up and Over Height	8.9m
Maximum Horizontal Reach	8.3m
Main Boom Up Angle	75°
Main Boom Down Angle	-8°
Maximum Turntable Tail swing	0.1m
Wheelbase	2.0m
Minimum Turning Circle Inside	2.08m
Minimum Turning Circle Outside	3.30m
Turntable Rotation	± 180°
Platform Rotation	± 90°
Jib Up/Down Angle	+70° /-60°
Tire and Wheels	

Foam Filled Tire	
Size	17.5*6.75
Outer Diameter	700mm
Width	220mm

2.2 Performance Specification

Driving Speed	
Boom Stowed, high range	6km/h
Boom Raised or Extended	1.1km/h
Grade ability (Stowed)	30% for GTBZ16AE 25% for GTBZ18AE
Main Lift Up	35-45 sec
Main Lift Down	30-35 sec
Swing Right & Left	200-300 sec
Telescope Extend Out	25-30 sec
Telescope Retract In	20-25 sec
Platform Rotate R & L	10-15 sec
Jib Up	35-40 sec
Jib Down	35-40 sec
Lower and Mid Boom Up	45-55 sec
Lower and Mid Boom Down	45-55 sec

Machine Orientation When Doing Speed Tests

Lift: Boom Retracted. Telescope Retracted. Lift Up, Record Time, Lift Down, Record Time.

Swing: Boom at Full Elevation. Telescope Retracted. Swing the Turntable to the end stop. Swing the Opposite Direction, Record Time.

Telescope: Boom at Full Elevation; Telescope Retracted; Telescope Out, Record Time. Telescope In, Record Time.

Drive: Test to be done on a smooth level surface. The Driving Mode choosing Switch should be selected Run Mode and Drive Speed Controller pulled to limit. Start approximately 25 ft. (7.62 m) from starting point so that the unit is at maximum speed when starting the test. Results should be recorded for a 200 ft. (60.96 m) course. Drive Forward, record time. Drive Reverse, Record Time.

Drive (Above Horizontal): Test should be done on a smooth level surface. Driving Mode choosing Switch should be selected Creep Mode and Drive Speed Controller pulled to limit. This verifies that the switches are working when the boom is above horizontal. Results should be recorded for a 50 ft. course. Drive Forward, Record Time. Drive Reverse, Record Time.

Platform Rotate: Platform level and completely rotated one direction. Rotate the opposite direction, Record Time. Rotate the other direction, Record Time.

Articulating Jib: Platform level and centered with the boom. Start with the Jib down. Jib Up, Record Time. Jib Down, Record Time.

Lower Lift: Upper Boom horizontal. Telescoped In. Lower Lift Up, Record Time. Lower Lift Down, Record Time.

Test Notes

1. Stop watch should be started with the function, not with the controller or switch.
2. Drive test results reflect 17.5*6.75 tires.
3. All speed tests are run from the platform. These speeds do not reflect the ground control operation.
4. The platform speed Toggle Switch control must be at full speed
5. Function speeds may vary due to cold, thick hydraulic oil. Test should be run with the oil temperature above 100° F (38° C).
6. Some flow control functions may not work with the speed knob clicked into the creep position.

2.3 Hydraulic System Specification

Drive Motor	
Type	Electrical Motor
Input Volts	48V AC
Power	3.3kw
Pump	
Type	Gear Pump
Rated Working Pressure	240 bar
Displacement per revolution	3.2cc
Hydraulic Tank Return Filter	10um
Function Manifold	
Function Main Relief Pressure, used for Main Boom Up and Down	190bar

Function Main Relief Pressure, used for Lower & Mid Boom Up and Down	190 bar
Turntable Swing Pressure Setting	60 bar
Main Boom Telescopic Extend and Retract Pressure Setting	190 bar
Jib Up and Down Pressure Setting	140 bar
Platform Level Up Pressure Setting	170 bar
Platform Level Down Pressure Setting	170 bar
Steering Pressure Setting	150 bar
Hydraulic Reservoir	
Maximum Capacity	30L
Auxiliary Pump Unit	
Hand Pump	LHP-10
Rated Pressure	0.4 MPa

2.4 Battery Specification

Type	Flooded/wet lead-acid battery
Mode	L16P-AC
Output Volts	6V DC
Material	Polypropylene
Number	8

2.5 Bolt Torque Specification

Thread Size	Class 8.8 Metric Bolts and Nuts (Nm)	Class 10.9 Metric Bolts and Nuts (Nm)	Class 12.9 Metric Bolts and Nuts (Nm)
M4	3	4.4	5.1
M5	5.9	8.7	10
M6	10	16	18
M8	25	36	43
M8×1	27	39	46
M10	49	72	84
M10×1	52	76	90
M12×1.25	93	135	160
M12×1.5	89	130	155
M12	86	126	145
M14×1.5	145	215	255
M14	135	200	236
M16×1.5	226	330	390
M16	210	310	365
M18×1.5	340	485	570
M18	300	430	600
M20×1.5	475	680	790
M20	425	610	710
M22×1.5	630	900	1050
M22	580	820	960
M24×2	800	1150	1350
M24	730	1050	1220
M27×2	1150	1650	1950
M27	1100	1550	1800
M30×2	1650	2350	2750
M30	1450	2100	2450

User responsibility, Machine Preparation and Inspection

Section 3

3.1 Personnel Training

The aerial platform is a personnel handling device; so it is necessary that it be operated and maintained only by trained personnel.

WARNING

PERSONS UNDER THE INFLUENCE OF DRUGS OR ALCOHOL OR WHO ARE SUBJECT TO SEIZURES, DIZZINESS OR LOSS OF PHYSICAL CONTROL MUST NOT OPERATE THIS MACHINE.

3.1.1 Operator Training

Operator training must cover:

- Use and limitations of the controls in the platform and at the ground, emergency controls and safety systems.
- Control labels, instructions, and warnings on the machine.
- Rules of the employer and government regulations.
- Use of approved fall protection device.
- Enough knowledge of the mechanical operation of the machine to recognize a malfunction or potential malfunction.
- The safest means to operate the machine where overhead obstructions, other moving equipment, and obstacles, depressions, holes, drop offs.
- Means to avoid the hazards of unprotected electrical conductors.
- Specific job requirements or machine application.

3.1.2 Training Supervision

Training must be done under the supervision of a qualified person in an open area free of obstructions until the trainee has developed the ability to safely control and operate the machine.

3.1.3 Operator Responsibility

The operator must be instructed that he/she has the responsibility and authority to shut down the machine in case of a malfunction or other unsafe condition of either the machine or the job site.

3.2 Preparation, Inspection and Maintenance

3.2.1 General

This section provides the necessary information needed by those personnel that are responsible to place the machine in operation readiness, and lists checks that are performed prior to use of the machine. It is important that the information contained in this section be read and understood before any attempt is made to operate the machine. Ensure that all the necessary inspections have been completed successfully before placing the machine into service. These procedures will aid in obtaining maximum service life and safe operation.

The following table covers the periodic machine inspections and maintenance recommended by Dingli Machinery Co.,Ltd. Consult local regulations for further requirements for aerial work platforms. The frequency of inspections and maintenance must be increased as necessary when the machine is used in a harsh or hostile environment, if the machine is used with increased frequency, or if the machine is used in a severe manner.

Table 3-1. Inspection and Maintenance Table

Type	Frequency	Primary Responsibility	Reference
Pre-Start Inspection	Before using each day; or whenever there's an Operator change.	User or Operator	Operation and Maintenance Manual
Pre-Delivery Inspection	Before each sale, lease, or rental delivery.	Owner, Dealer, or User	Operation and Maintenance Manual
Frequent Inspection	In service for 3 months or 150 hours, whichever comes first; or Out of service for a period of more than 3 months; or Purchased used.	Owner, Dealer, or User	Operation and Maintenance Manual
Annual Machine Inspection	Annually, no later than 13 months from the date of prior inspection.	Owner, Dealer, or User	Operation and Maintenance Manual
Preventative Maintenance	At intervals as specified in the Operation & Maintenance Manual	Owner, Dealer, or User	Operation and Maintenance Manual

3.2.2 Preparation for Use

Before a new machine is put into operation it must be carefully inspected for any evidence of damage resulting from shipment and inspected periodically thereafter, as outlined in Delivery and Frequent Inspection (see section 3.2.3). During initial start-up and run, the unit should be thoroughly checked for hydraulic leaks. A check of all components should be made to assure their security.

All preparation necessary to place the machine in operation readiness status is the responsibility of management personnel. Preparation requires good common sense, (i.e. telescope works smoothly and brakes operate properly) coupled with a series of visual inspections. The mandatory requirements are given in the Daily Walk around Inspection (see section 3.2.4).

It should be assured that the items appearing in the Delivery and Frequent Inspection and Functional Check are complied with prior to putting the machine into service.

3.2.3 Delivery and Frequent Inspection

NOTICE

AN ANNUAL INSPECTION SHALL BE PERFORMED ON THE AERIAL PLATFORM NO LATER THAN THIRTEEN (13) MONTHS FORM THE DATE OF THE PRIOR ANNUAL INSPECTION. THE INSPECTION SHALL BE PERFORMED BY PERSON(S) QUALIFIED AS A MECHANIC ON THE SPECIFIC MAKE AND MODEL OF THE AERIAL PLATFORM.

The following checklist provides a systematic inspection to assist in detecting defective, damaged, or improperly installed parts. The checklist denotes the items to be inspected and conditions to examine. Frequent inspection shall be performed every 3 months or 150 hours whichever comes first or more often when required by environment, severity, and frequency of usage.

This inspection checklist is also applicable and must be followed for all machines that have been in storage or for all machines that will be exposed to harsh or changing climates. These checks are also to be performed after maintenance has been performed on the machine.

Chassis

- 1) Check front tires and wheel assemblies for loose or worn spindles, components and hardware for security, tires for wear and damage.
- 2) Check steering assembly for loose or bent tie rod, cylinder and hydraulic lines for leaks and security, and hardware for proper installation.
- 3) Check drive hubs, electric motors, brakes and electric lines for damage and leaks. Contact Service Personnel for assistance if needed.
- 4) Check rear tires and wheel assemblies for security, tires for wear and damage.
- 5) Check Hydraulic Reservoir for security, hydraulic elements in(on) the Hydraulic Reservoir for wear and damage.
- 6) Check oil level in drive hub by removing pipe plug on side and feeling for oil level. (Contact Service Personnel for assistance if needed).

NOTICE

TORQUE HUBS SHOULD BE ONE-HALF FULL OF LUBRICANT.

- 7) Check Hydraulic and Electric Elements for wear and damage.

Turntable

- 1) Check turntable for damage, loose or missing parts, and security. Check swing drive and brake for damage, loose or missing parts, hydraulic lines and component housings for evidence of leakage; worm gear for proper mesh with swing gear.
- 2) Check swing bearing for damage, wear, lubrication and loose or missing bearing bolts.
- 3) Check solenoid valves and hydraulic lines for damage, leakage, security and electrical connections for tightness and evidence of corrosion.
- 4) Check ground controls for damage, loose or missing parts, security and electric connections for evidence of corrosion and tightness and wiring for insulation damage. Assure that all switches function properly.
- 5) Check battery for damage, loose or missing vent caps, electrical connections for tightness, and evidence of corrosion, hold-down brackets for tightness, and electrolyte for proper water level. Add only clean distilled water to battery.
- 6) Check all access doors for damage, proper operation of latches, props and security.
- 7) Check Function Manifold and hydraulic lines for damage, leakage and security.

NOTICE

DINGLI CO.,LTD. RECOMMENDS REPLACING THE HYDRAULIC FILTER ELEMENT AFTER THE FIRST 50 HOURS OF OPERATION AND THEN EVERY 300 HOURS THEREAFTER, UNLESS SYSTEM INDICATOR REQUIRE EARLIER REPLACEMENT.

- 8) Check all pin and shaft retaining hardware for security and wear.
- 9) Check all electrical cables for defects, damage, loose or corroded connections.

Boom

- 1) Check Lower Boom and leveling link for damage, missing parts and security.
- 2) Check all pin and shaft retaining hardware for security and wear.
- 3) Check hydraulic lines and electrical cable for damage, missing parts and security.
- 4) Check limits switch connections and plunger for corrosion and security.
- 5) Check Lower Upright, cross pins, lower hydraulic cylinder and hydraulic lines for damage, wear, lubrication, leakage and security.
- 6) Check boom pivot bushings for wear.
- 7) Check Upper Upright, cross pins, upper lift cylinder and hydraulic lines for damage, wear, lubrication, leakage and security.
- 8) Check Upper Boom for damage, missing parts and security.
- 9) Check Upper Boom wear pads for damage, missing parts and security.

- 10) Check Upper Boom telescope cylinder, cross pins and hydraulic lines for damage, wear, lubrication, leakage and security.
- 11) Check Platform Leveling Cylinder, cross pins and hydraulic lines for damage, wear, lubrication, leakage and security.
- 12) Check jib articulating cylinder, cross pins and hydraulic lines for damage, wear, lubrication, leakage and security.
- 13) Check solenoid valve for transition platform swinging and jib lifting, connection-peg and cable for damage, wear and security.

Platform

- 1) Check platform and control console for damage, loose or missing parts, and security.
- 2) Check control switches and levers for damage, loose or missing parts and security. Assure that levers function properly.
- 3) Check control switches, levers and electrical connections for tightness and evidence of corrosion, and wiring for defects and chafing damage. Assure that switches function properly.
- 4) Check access gate hinges, stop, and latch for proper operation, damage and security.
- 5) Check platform rotator mechanism for proper operation, damage, security. Check hydraulic lines for leakage, damage and security.

NOTICE

***CHECK ALL DANGER, WARNING, CAUTION AND INSTRUCTION
PLACARDS FOR LEGIBILITY AND SECURITY ON THE ENTIRE MACHINE.
(REFER TO SECTION 4.4 PLACARDS AND DECALS)***

Torque Requirements

The Reference Torque Value for Metric Thread Table (Figure 2-5.) consists of standard Metric bolts and Nuts torque values based on bolt diameter and grade, also specifying dry and wet torque values in accordance with recommended shop practices. This chart is provided as an aid to the operator in the event he/she notices a condition that requires prompt attention during the walk-around inspection or during operation, until the proper service personnel can be notified. The Service and Maintenance manual provides specific torque values and periodic maintenance procedures with a listing of individual components. Utilizing this Torque Value Table in conjunction with the preventive maintenance section will enhance safety, reliability, and performance of the machine.

3.2.4 Daily Walk-around Inspection

It is the operator's responsibility to inspect the machine before the start of each workday. It is recommended that each operator inspect the machine before operation, even if the machine has already been put into service under another operator. This Daily Walk-Around Inspection is the preferred method of inspection. These checks are also to be performed after maintenance has been performed on the machine.

In addition to the Daily Walk-Around Inspection, be sure to include the following as part of the daily inspection:

1) Overall cleanliness.

Check all standing surfaces for oil, hydraulic oil spillage and foreign objects. Ensure overall cleanliness.

2) Placards.

Keep all information and operating placards clean and unobstructed. Cover when spray painting or shot blasting to protect legibility.

3) Operation and Maintenance Manual.

Ensure a copy of this manual and other Safety Manual, are enclosed in the manual storage box.

4) Machine Log.

Ensure a machine operating record or log is kept, check to see that it is current and that no entries have been left unlearned, leaving machine in an unsafe condition for operation.

⚠ WARNING

TO AVOID INJURY, DO NOT OPERATE A MACHINE UNTIL ALL MALFUNCTIONS HAVE BEEN CORRECTED. USE OF A MALFUNCTIONING MACHINE IS A SAFETY VIOLATION. TO AVOID POSSIBLE INJURY, BE SURE MACHINE POWER IS "OFF" DURING WALK-AROUND INSPECTION.

NOTICE

CHECK BOOM LIMIT SWITCHES ON UPRIGHT FOR PROPER OPERATION AND SECURITY, BOTH VISUALLY AND MANUALLY. THE LOWER SWITCH CUTS OUT DRIVE SPEED WHEN THE LOWER BOOM IS ABOVE HORIZONTAL. THE UPPER SWITCH CUTS OUT DRIVE SPEED WHEN THE UPPER BOOM IS ABOVE HORIZONTAL. ONLY CREEP DRIVE SPEED WILL CONTINUE TO FUNCTION.

5) Check platform footswitch for proper operation.

Switch must be released to start and depressed to operate machine.

6) Check that drive brakes hold when machine is driven up a grade not greater than specified on the serial number placard and stopped.

NOTICE

ON NEW MACHINES, THOSE RECENTLY OVERHAULED, OR AFTER CHANGING HYDRAULIC OIL, OPERATE ALL SYSTEMS A MINIMUM OF TWO COMPLETE CYCLES AND RECHECK OIL LEVEL IN RESERVOIR.

7) Assure that all items requiring lubrication are serviced.

Refer to Figure 3-1, Daily Walk-around Inspection Position.

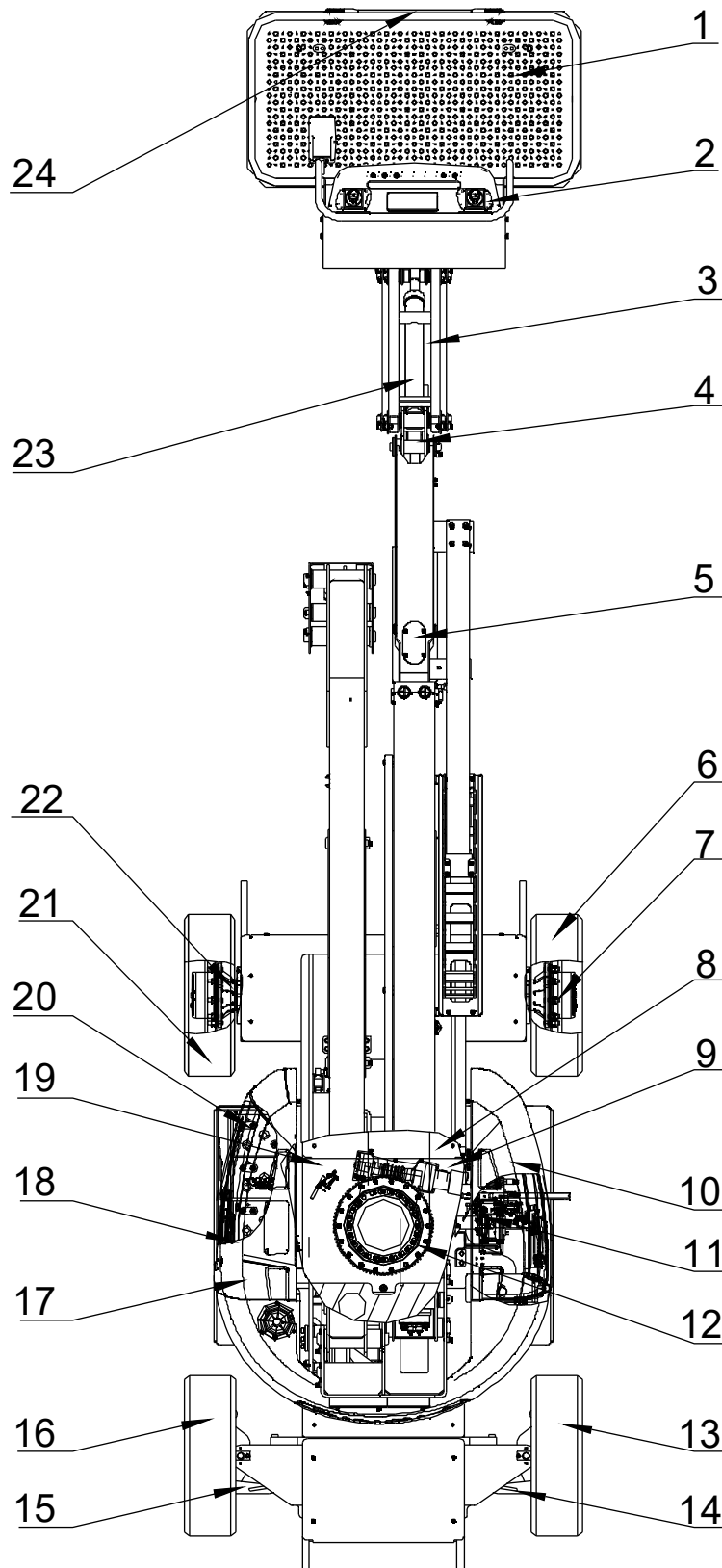

Figure 3-1 Daily Walk-around Inspection Position

Walk-Around Inspection Checklist

- 1) **Platform Assembly** – No loose or missing parts, no visible damage. Lock bolts in place. Footswitch in good working order not modified disabled or blocked.
- 2) **Platform Control Console** – Switches and levers return to neutral and are properly secured, no loose or missing parts, no visible damage, decals/placards secure and legible, control marking legible.
- 3) **Jib Articulating Cylinder** – No visible damage; pivot pins secure; hydraulic hoses undamaged, not leaking.
- 4) **Slave Cylinder** – No visible damage; pivot pins secure; hydraulic hoses undamaged, not leaking
- 5) **Boom Sections/Uprights/Lift Cylinders and Master Cylinder** – No visible damage; pivot pins secure; hydraulic hoses undamaged, not leaking. Uprights in vertical position.
- 6) **Wheel/Tire Assembly, Left Rear** – Properly secured, no loose or missing lug nuts, no visible damage.
- 7) **Drive Motor, Brake, and Hub** – No visible damage.
- 8) **Hydraulic Oil Supply** – Recommended oil level sight gauge. (Check level with cold oil, systems shut down, machine in stowed position) Cap in place and secure.
Hydraulic Filter – Housing secure no visible damage; no evidence of leakage,
- 9) **Tilt Sensor** – Switches operable; no visible damage.
- 10) **Hood, Left Side** – Properly secured; no loose or missing parts.
- 11) **Control Valve** – No loose or missing parts; evidence of leakage; unsupported wires or hoses; damaged or broken wires.
- 12) **Turntable Bearing** – No loose or missing hardware; no visible; evidence of proper lubrication; no evidence of loose bolts or looseness between bearing or structure.
Swing Motor and Worm Gear – No loose or missing hardware; no visible damage; evidence of proper lubrication.
- 13) **Wheel/Tire Assembly, Left Front** – Properly secured, no loose or missing lug nuts, no visible damage.
- 14) **Tie Rod Ends and Steering Spindles** – No loose or missing parts; no visible damage.
Steer Cylinder – Properly secured; no visible damage or signs of leakage; evidence of proper lubrication.
- 15) **Tie Rod Ends and Steering Spindles** – No loose or missing parts; no visible damage.
Steer Cylinder – Properly secured; no visible damage or signs of leakage; evidence of proper lubrication.
- 16) **Wheel/Tire Assembly, Right Front** – Properly secured, no loose or missing lug nuts, no visible damage.

- 17) **Hood, Right Side** – Properly secured; no loose or missing parts
- 18) **Ground Controls** – Switches operable, no visible damage, decals secure and legible.
- 19) **Hydraulic Pump** – No loose or missing parts, no evidence
- 20) **Battery** – Proper electrolyte levels; cables tight, no visible damage or corrosion.
- 21) **Wheel/Tire Assembly, Right Rear** – Properly secured, no loose or missing lug nuts, no visible damage.
- 22) **Drive Motor, Brake, and Hub** – No visible damage; no evidence of leakage.
- 23) **Rotator Cylinders** – No visible damage; cylinder bolts secure; hydraulic hoses undamaged and not leaking.
- 24) **Platform Gate** – Latch, stop, and hinges in working condition and properly secured; no loose or missing parts.

3.2.5 Daily Function Check

A functional check of all systems must be performed, once the walk-around inspection is complete, in an area free of overhead and ground level obstructions. First, using the ground controls, check all functions controlled by the ground controls. Next, using the platform controls, check all functions controlled by the platform controls.

WARNING

TO AVOID SERIOUS INJURY, DO NOT OPERATE MACHINE IF ANY CONTROL LEVERS OR TOGGLE SWITCHES CONTROLLING PLATFORM MOVEMENTS DO NOT RETURN TO THE OFF OR NEUTRAL POSITION WHEN RELEASED.

TO AVOID A COLLISION AND INJURY IF PLATFORM DOES NOT STOP WHEN A CONTROL SWITCH OR LEVER IS RELEASED, REMOVE FOOT FROM FOOTSWITCH OR USE EMERGENCY STOP TO STOP THE MACHINE.

IF THE MACHINE DOES NOT OPERATE PROPERLY, TURN OFF THE MACHINE IMMEDIATELY! REPORT THE PROBLEM TO THE PROPER MAINTENANCE PERSONNEL. DO NOT OPERATE THE MACHINE UNTIL IT IS DECLARED SAFE FOR OPERATION.

NOTICE

WHEN THE BOOM IS RAISED ABOVE HORIZONTAL, HIGH DRIVE SPEED IS CUT OUT.

- 1) Check boom horizontal limit switches to see that they are operable and not damaged. Raise and lower Boom. Check for smooth operation. Check Boom Upright tilting for proper synchronization. If the upright is tilted or the boom will not fully lower, refer to the Boom Operation in Section 5.8.

NOTICE

PERFORM CHECKS FROM GROUND CONTROLS FIRST, THEN FROM PLATFORM CONTROLS.

- 2) Raise, extend, retract and lower Upper Boom. Check for smooth operation.
- 3) Telescope boom IN and OUT several cycles at various degrees of elevation lengths. Check for smooth telescope operation.
- 4) Swing turntable to LEFT and RIGHT a minimum of 45 degrees. Check for smooth motion.
- 5) With the aid of an assistant to monitor the CHASSIS OUT OF LEVEL indicator light on the platform console, manually activate the indicator light by compressing one of the three tilt indicator mounting springs. If the light does not illuminate, shut down machine and contact a qualified service technician before continuing operation.
- 6) Check that platform self-leveling system functions properly during raising and lowering of boom.
- 7) Check rotator for smooth operation and assure platform will rotate 90 degrees in both directions from centerline of boom.
- 8) Drive forward and reverse; check for proper operation.
- 9) Steer left and right; checks for proper operation.
- 10) Footswitch.

⚠ WARNING

FOOTSWITCH MUST BE ADJUSTED SO THAT FUNCTIONS WILL OPERATE WHEN PEDAL IS APPROXIMATELY AT ITS CENTER OF TRAVEL. IF SWITCH OPERATES WITHIN LAST 1/4" OF TRAVEL, TOP OR BOTTOM, IT SHOULD BE ADJUSTED.

- A. Activate hydraulic system, by depressing footswitch. Operate Telescope and hold control. Remove foot from footswitch, motion should stop. If it does not, shut down machine and contact a certified service technician.
 - B. With footswitch depressed, operate Lift and hold control. Remove foot from footswitch, motion should stop. If it does not, shut down machine and contact a certified service technician.
- 11) Auxiliary Power.
Operate Lower Lift and Upper Lift to assure that they function in down directions using auxiliary power instead of battery.
 - 12) Ground Controls.
Place Ground/Platform Select switch to Ground.
Platform controls should not operate.

Machine Controls and Indicators

Section 4

4.1 General

NOTICE

THE MANUFACTURER HAS NO DIRECT CONTROL OVER MACHINE APPLICATION AND OPERATION. THE USER AND OPERATOR ARE RESPONSIBLE FOR CONFORMING WITH GOOD SAFETY PRACTICES.

This section provides the necessary information needed to understand control functions.

4.2 Controls and Indicators

4.2.1 Ground Control Station

NOTE: If equipped, the Function Enable switch must be held down in order to operate Telescope, Swing, Tower Lift, Main Lift, Jib Lift, Platform Level Override, and Platform Rotate functions.

⚠ WARNING

DO NOT OPERATE FROM GROUND CONTROL STATION WITH PERSONNEL IN THE PLATFORM EXCEPT IN AN EMERGENCY.

PERFORM AS MANY PRE-OPERATIONAL CHECK AND INSPECTIONS FROM GROUND CONTROLS AS POSSIBLE.

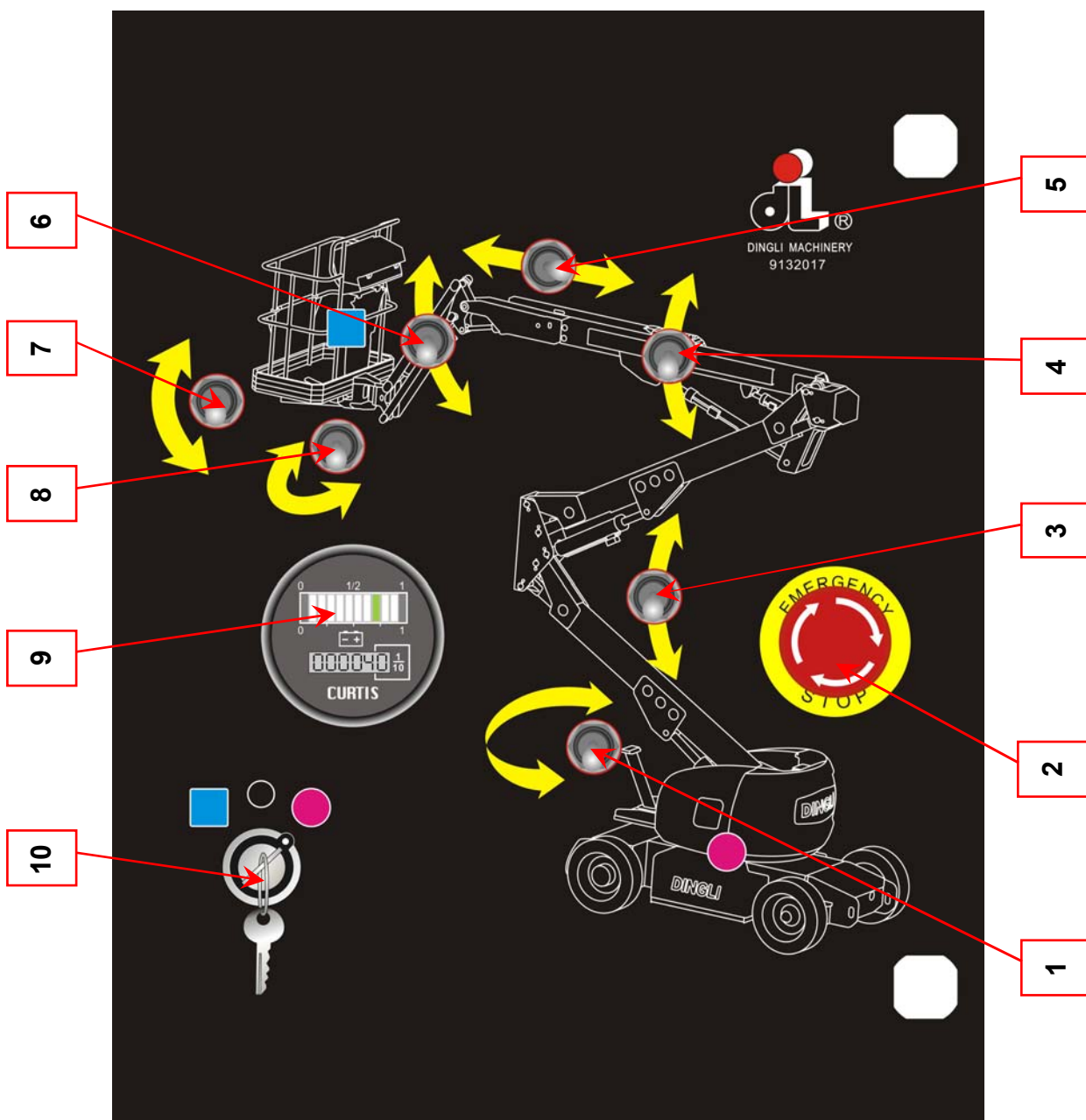
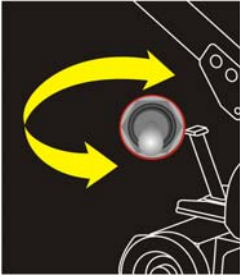

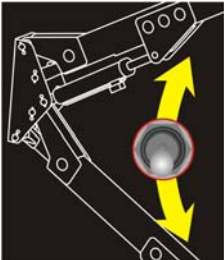
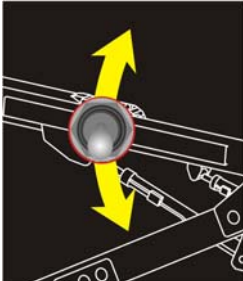
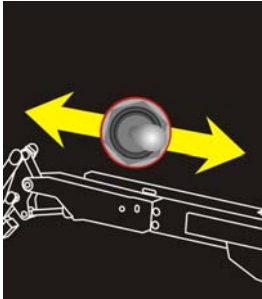
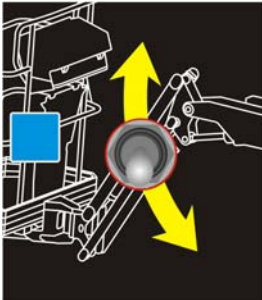

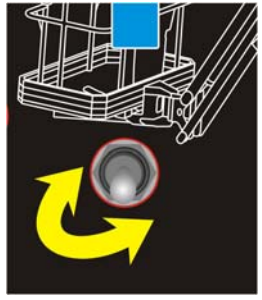

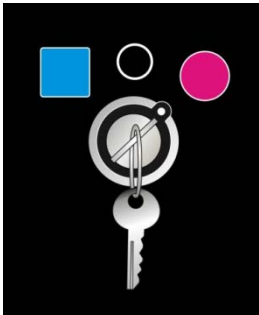

Figure 4-1 Ground Console Panel

Table 4-1 the Explanation for the Ground Console Panel

Item	Name	Description
1	<p>The Turntable Swing Control Switch</p> 	<p>A three position Toggle Switch allows the operator to swing the turntable clockwise or anticlockwise according the indication direction. It would return Back to Original Position Automatically once be released.</p>
2	<p>Emergency Button</p> 	<p>A two-position red mushroom shaped switch furnishes power to the system, it is used to turn off the system power in emergency situation.</p> <ul style="list-style-type: none"> ● Push Down to turn (OFF) the switch, so the power is shut off. ● Before starting system power, the emergency button must be released, if not, the machine can not be started. Turning the mushroom clockwise to turn ON the switch, so to provide the power to the system.
3	<p>The Control Switch for Lower and Mid Boom Up & Down</p> 	<p>A Three Position Toggle Switch. Push the toggle lever Up according to UP Arrow direction, the Lower and the Mid Boom would be raised simultaneously, until the Boom Up to the Up limited position. And Push the toggle lever to the opposite direction, the Lower and Mid Boom would be got Down until the Boom to the Lowest Position. Once the toggle lever is released, it would return to the Original position automatically.</p>
4	<p>The Main Boom Up and Down Switch</p> 	<p>A Three Position Toggle Switch. Push the toggle lever Up according to UP Arrow direction, the Main Boom would be raised, until the Boom Up to the Up limited position. And Push the toggle lever to the opposite direction, the Main Boom would be got Down until the Boom to the Lowest Position. Once the toggle lever is released, it would return to the Original position automatically.</p>

<p>5</p>	<p>The Main Boom Telescopic Controller</p> 	<p>A Three Position Toggle Switch. Push the toggle lever LEFT according to LEFT Arrow direction, the Main Boom would be Extended, until the Boom extend to the extending limited position. And Push the toggle lever to the opposite direction, the Main Boom would be extended until the Boom to the retracting Position. Once the toggle lever is released, it would return to the Original position automatically.</p>
<p>6</p>	<p>The Jib Boom Up & Down Controller</p> 	<p>A Three Position Toggle Switch. Push the toggle lever Up according to UP Arrow direction, the Jib Boom would be raised, until the Boom Up to the Up limited position. And Push the toggle lever to the opposite direction, the Jib Boom would be got Down until the Boom to the Lowest Position. Once the toggle lever is released. It would return to the Original position automatically.</p>
<p>7</p>	<p>The Platform Leveling Controller</p> 	<p>A three position switch allows the operator to adjust the automatic self leveling system. This switch is used to adjust the platform level in situations such as ascending/descending a grad.</p> <div style="text-align: center;">  <p>WARNING</p> <p><i>ONLY USE THE PLATFORM LEVELING OVERRIDE FUNCTION FOR SLIGHT LEVELING OF THE PLATFORM. INCORRECT USE COULD CAUSE THE LOAD/OCCUPANTS TO SHIFT OR FALL. FAILURE TO DO SO COULD RESULT IN DEATH OR SERIOUS INJURY.</i></p> </div>
<p>8</p>	<p>The Platform Rotate Controller</p> 	<p>A three position Toggle Switch allows the operator to swing the platform clockwise or anticlockwise according the indication direction. It would return Back to Original Position Automatically once be released.</p> <div style="text-align: center;">  <p>NOTICE</p> <p><i>Range of platform swinging: ±90°</i></p> </div>

<p>9</p>	<p>The Multifunction Gauge</p> 	<p>The Multifunction Gauge, is used to Display the</p> <ul style="list-style-type: none"> ● Working Hours ● Battery level
<p>10</p>	<p>The Ground and Platform Console Selecting Switch</p> 	<p>A three position toggle switch is used to supplies power to the platform console or platform console when positioned to Platform.</p> <ul style="list-style-type: none"> ● Normally, it is in Neutral, the Power is cut off ● Turn the Key Switch Counter-clockwise to the Blue Square Position, the machine would be controlled by the Platform Console ● Turn the Key Switch Clockwise to the Red Circle Position, the machine would be controlled by the Ground Console. <p style="text-align: center;">NOTICE</p> <p><i>When machine is shut down the Platform/Ground Select switch and Emergency Stop must be positioned to OFF.</i></p> <p><i>With PLATFORM/GROUND SELECT switch in the center position, power is shut off to controls at both operating Console.</i></p>

4.2.2 Platform Control Station

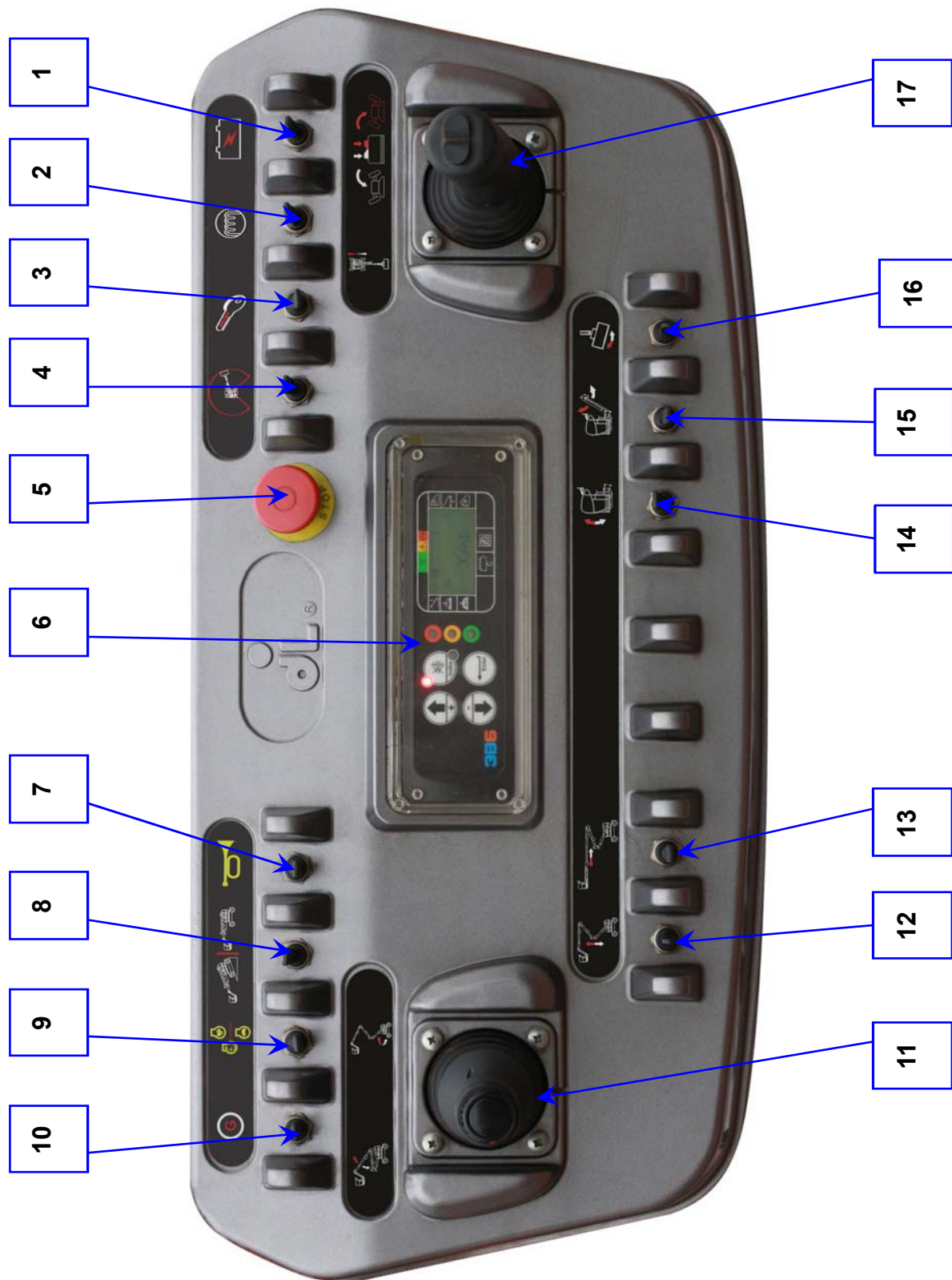

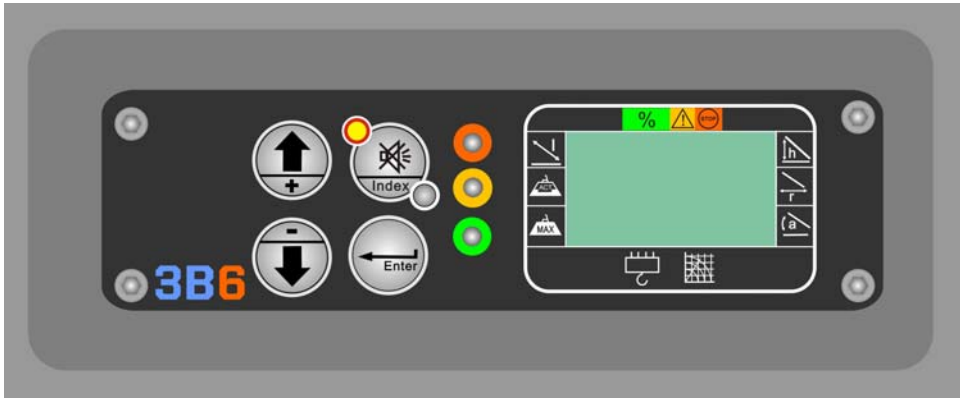
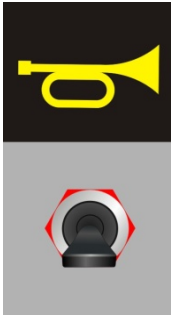
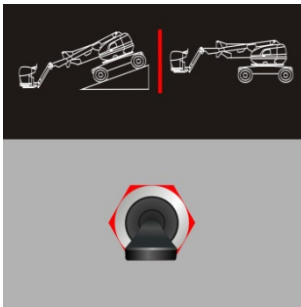
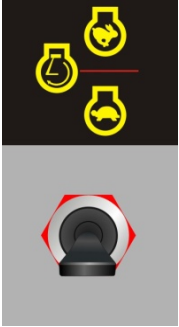
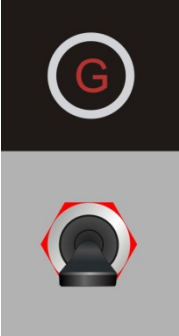
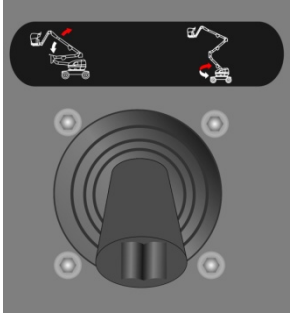

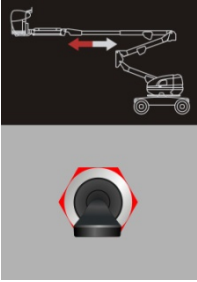
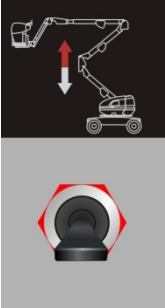

Figure 4-2 Platform Console Panel

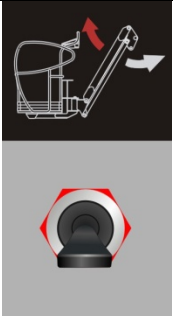

Table 4-2 The Explanations for the Platform Console

Item	Name	Description
1	The Auxiliary Power Control Switch 	Not used
2	The Glow Plug Control Switch 	Not used
3	The Engine Start Switch 	Not used
4	The Driving Enable Override Switch 	Not used

<p>5</p>	<p>Emergency Button</p> 	<p>A two-position red mushroom shaped switch furnishes power to the system; it is used to turn off the system power in emergency situation.</p> <ul style="list-style-type: none"> ● Push Down to turn (OFF) the switch, so the power is shut off. ● Before starting system power, the emergency button must be released, if not, the machine can not be started. Turning the mushroom clockwise to turn ON the switch, so to provide the power to the system.
<p>6</p>	<p>The Control EUM Unit and Panel</p>  <p>Refer to Display Panel for detail information</p>	
<p>7</p>	<p>The Horn Button</p> 	<p>A Two Position Toggle Switch. If pressed, this switch supplies power to the horn. It would return Back to Original Position Automatically once be released.</p>
<p>8</p>	<p>The Driving Mode Choosing Switch</p> 	<p>A Two Position Toggle Switch, which is used to Set the Driving Mode.</p> <ul style="list-style-type: none"> ● Turn the Toggle Switch to Right position, the machine can provide maximum drive speed ● Turn the Toggle Switch to Left position, the machine can provide maximum torque for rough terrain and climbing grades.

		<p style="text-align: center;">⚠ CAUTION</p> <p><i>If the machine is not stowed, it would be only driven a low speed, less than 1.1km/h.If not, shut down machine and contact a qualified service technician before continuing operation. Failure to do so could result in death or serious injury.</i></p>
9	<p>The Engine Speed Control Switch</p> 	<ul style="list-style-type: none"> ● Not used
10	<p>AC Generator</p> 	<p>Not used</p>
11	<p>The Main Boom Controller</p> 	<p>The dual axis joystick is provided for main lift and swing.</p> <ul style="list-style-type: none"> ● Push down the button in the front surface of the main boom controller and hold on ,then Push forward and hold on to raise the main boom (Upper boom) up, pull backward to lower the main boom (Upper boom). ● Move right to swing the turntable anticlockwise; move left to swing the turntable clockwise. <p style="text-align: center;">NOTICE</p> <p><i>Main lift and swing functions can't be selected at the same time. If not the alarm will be activated.</i></p>

<p>12</p>	<p>The Main Boom Telescopic Control Switch</p> 	<p>A Three Position Toggle Switch. Push the toggle lever LEFT according to LEFT Arrow direction, the Main Boom would be Extended, until the Boom extends to the extending limited position. And Push the toggle lever to the opposite direction, the Main Boom would be extended until the Boom to the retracting Position. Once the toggle lever is released, it would return to the Original position automatically.</p>
<p>13</p>	<p>The Lower and Mid Boom Control Switch</p> 	<p>A Three Position Toggle Switch. Push the toggle lever Up according to UP Arrow direction, the Lower and the Mid Boom would be raised simultaneously, until the Boom Up to the Up limited position. And Push the toggle lever to the opposite direction, the Lower and Mid Boom would be get Down until the Boom to the Lowest Position. Once the toggle lever is released, it would return to the Original position.</p>
<p>14</p>	<p>The Platform Leveling Control Switch</p> 	<p>A three position switch allows the operator to adjust the automatic self leveling system. This switch is used to adjust the platform level in situations such as ascending/descending a grade.</p> <div style="text-align: center;">  <p>WARNING</p> <p><i>ONLY USE THE PLATFORM LEVELING OVERRIDE FUNCTION FOR SLIGHT LEVELING OF THE PLATFORM. INCORRECT USE COULD CAUSE THE LOAD/OCCUPANTS TO SHIFT OR FALL. FAILURE TO DO SO COULD RESULT IN DEATH OR SERIOUS INJURY.</i></p> </div>
<p>15</p>	<p>The Jib Boom Up & Down Control Switch</p>	<p>A Three Position Toggle Switch. Push the toggle lever Up according to UP Arrow direction, the Jib Boom would be raised, until the Boom Up to the Up limited position. And Push the toggle lever to the opposite direction, the Jib Boom would be got Down until the Boom to the Lowest Position. Once the toggle lever is released, it would return to the Original position automatically.</p>

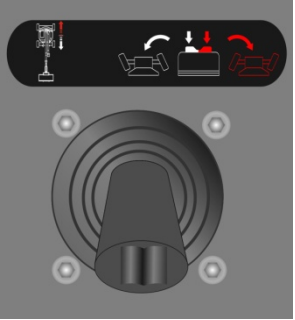
		
<p>16</p>	<p>The Platform Rotate Control Switch</p> 	<p>A three position Toggle Switch allows the operator to swing the platform clockwise or anticlockwise according the indication direction. It would return Back to Original Position Automatically once be released.</p> <p style="text-align: center;">NOTICE</p> <p style="text-align: center;"><i>Range of platform swinging: ±90°</i></p>
<p>17</p>	<p>Drive/Steer Controller</p> 	<p>Drive/Steer</p> <p>The DRIVE joystick provides for driving either forward or backward. The controller is ramped to allow variable drive speed.</p> <p>Steering is controlled by a thumb operated switch on top of the joystick.</p>

4.2.3 The Multi-Function Gauge

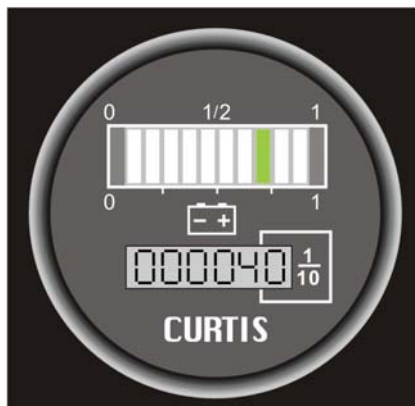



Figure 4-3 The Multi-Function Display Gauge

Table 4-3 The Explanations for the Multi-Function Gauge

Item	Name & Figure	Description
1		Displaying Battery level
2	Hours Meter	Displaying working hours in all. Before the reject of the machine.

4.2.4 The Control Unit Display Panel

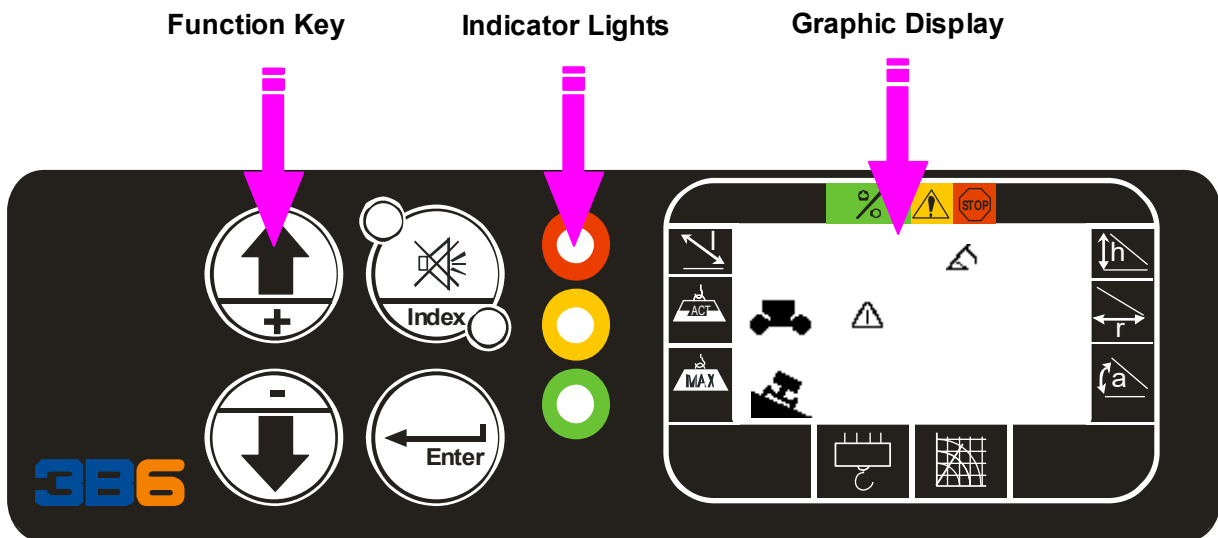









Figure 4-4 the LED Control& Display Configuration



Function Key Description:

Item	Name & Figure	Description
1		It is used to adjust the display panel contrast, press one time.
2		Go back to up class menu or display item. It is used to choose previews item when adjust the display menu.
3		Go down to the next display item. It is used to choose next item when adjust the display menu.
4		It is used to confirm you choosing when make adjusting for the control display.

Indicator Light Description:

Item	Name & Figure	Description
1		It is a red indicator light. It indicates that there are some warnings when it is illustrated.
2		It is a yellow indicator light. It indicates that the machine can be drove in High speed when it is illustrated.
3		It is a green indicator light. It indicates that the footswitch is depressed when it is illustrated.

The Icon in the Graphic Display Zone Description:

Item	Name & Figure	Description
1		The ground control station indicator. It would be shown when the selected key switch is turned to the ground control station.
2		Indicate that the machine chassis is inline and the degree is more than 3 degree when the boom isn't lowered and retracted completely. So, some function operation can't be operated.
3		Indicate that the emergency button is depressed down.
4	Battery Low	Indicate that the batteries need charging right away.

4.3 Tilt Alarm Warning

A Tilt Sensor is installed in the Turntable, which is used to detect if the chassis is horizontal. Once the Tilt Sensor detects that the chassis is inline and the inline degree is more than 3 degree, the sensor indicator light would turn to be red from green and an alarm will also sound as long as the lower and mid boom lifted, telescopic boom extended or main boom lifted. At the same time, red light on the platform control station will glitter and the corn indicating chassis inclining appear in the display. Then, the machine can't travel and the boom can't lift up and extend. The machine can be driven when the boom is lowered and retracted completely. Last, the machine should be driven to a safe and plat ground.



NOTICE

***THE FOLLOWING INFORMATION IS ONLY APPLICABLE TO CE MACHINE:
WHEN THE LEVEL OF THE CHASSIS EXCEED 3° AND ALARM4-1ED, ALL
OPERATIONS OF THE MACHINE WOULD NOT BE OPERATED.***

⚠ DANGER

***IT IS FORBIDDEN THAT RELEASE THE BOLT FIXING UP THE TILT SENSOR
TO FREE FROM ALARM, OTHERWISE, IT WOULD CAUSE SERIOUS
DAMAGE TO THE MACHINE OR DEATH TO PERSONS.***

4.4 Footswitch/Enable Indicator

To operate any function, the footswitch must be depressed and then to choose the function selected within seven seconds. If a function is not selected within seven seconds, or if a seven second lapse between ending one function and beginning the next function, the enable function would go out and the footswitch must be released and depressed again to enable the controls.



⚠ DANGER

***TO AVOID SERIOUS INJURY, DO NOT REMOVE, MODIFY OR DISABLE THE
FOOTSWITCH BY BLOCKING OR ANY OTHER MEANS.***

4.5 Placards and Decals

Read and understand all placards and decals. Do not operate any machine on which DANGER, WARNING, CAUTION OR INSTRUCTION PLACARDS OR DECALS ARE MISSING OR ILLEGIBLE. Replace placards and decals if damaged, missing or illegible.

Decals are made of Pressure Sensitive Adhesive with a protective film on the front. Remove the damaged decal and thoroughly clean surface before installing a new decal. Simply peel off the back, and press new decal onto surface.

NOTICE

PLACARDS AND DECALS CAN BE ORDERED BY USING PART NUMBERS LOCATED BY EACH PLACARD OR DECAL. (SEE FIGURE4-5 DANGER AND WARNING DECAL AND PLACARD LOCATION.)

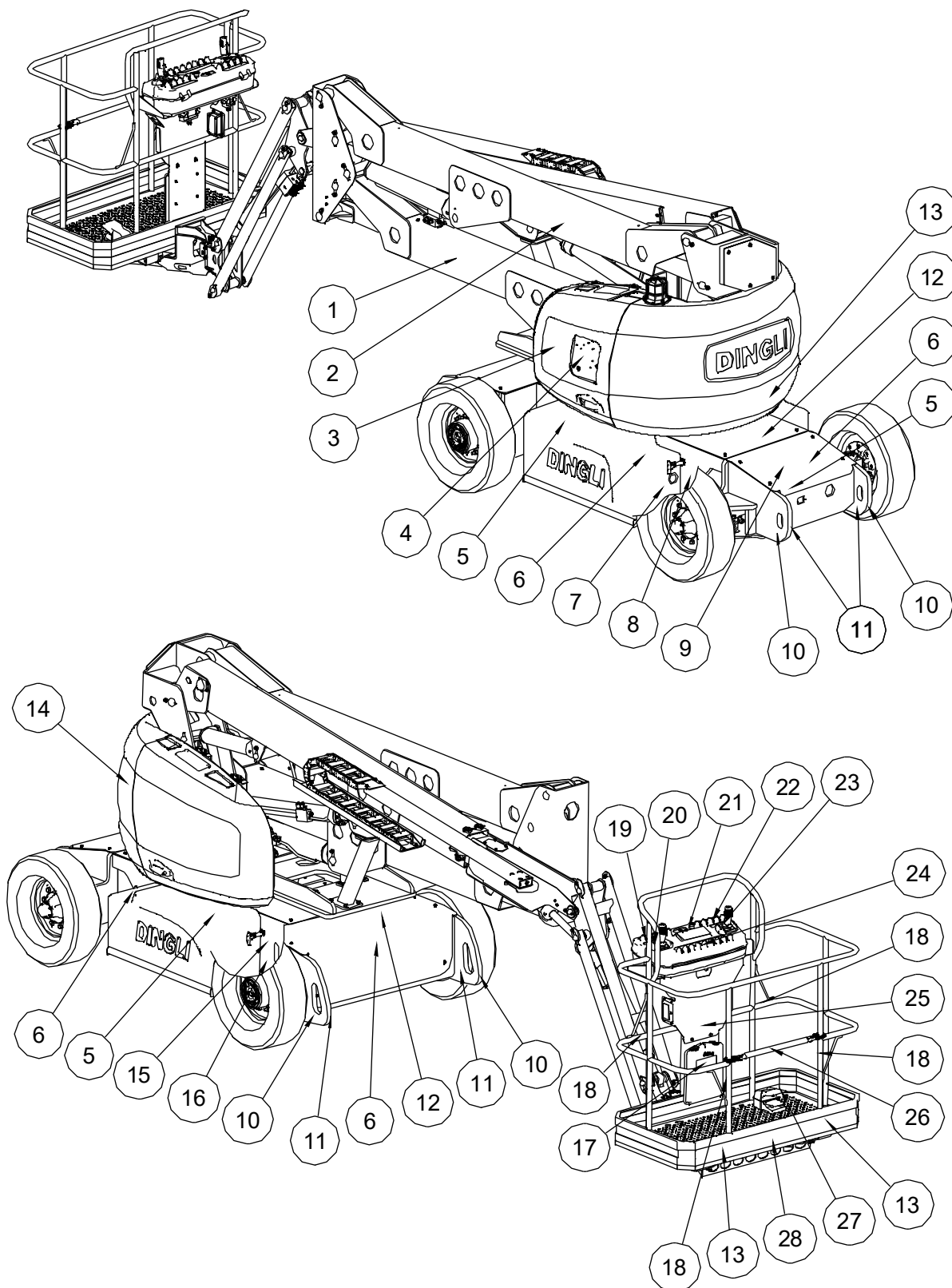

Figure4-5 Danger and Warning Decal Location

GTBZ16AE

Boom

① 9533011
② 9633015

Dingli GTBZ16AE

Chassis

③ 9432021

⑤ 9431011

④ 9132017

⑥ 9421013

⑦ 9311105

⑧ 9231013

⑨ 9331019

⑩ 9331013

⑪ 9331011

⑬ 9432013

⑫ 9331015

⑭ 9331017

⑮ 9332015

⑯ 9332017

Platform

⑰ 9334011

⑱ 9134011

⑲ 9134011

⑳ 9134015

㉑ 9134021

㉒ 9134013

㉓ 9134017

㉔ 9134019

㉕ 9434057

㉖ 9324011

㉗ 9434085

㉘ 9434081

㉙ 9434011

CAPACITY • 230kg

GTBZ18AE

Boom

① 9533011
② 9633019

Dingli GTBZ18AE

Chassis

③ 9432021

⑤ 9431011

④ 9132017

⑥ 9421013

⑦ 9311105

⑧ 9231013

⑨ 9331019

⑩ 9331013

⑪ 9331011

⑬ 9432013

⑫ 9331015

⑭ 9331017

⑮ 9332015

⑯ 9332017

Platform

⑰ 9334011

⑱ 9134011

⑲ 9134011

⑳ 9134015

㉑ 9134021

㉒ 9134013

㉓ 9134017

㉔ 9134019

㉕ 9434057

㉖ 9324011

㉗ 9434081

㉘ 9434085

㉙ 9434011

CAPACITY • 230kg

Table 4-3 the description for the placard and decal table

No.	Parts No.	Description	Qty.	Remark
1	9533011	Cosmetic – Mark	1	
2	9633015	Cosmetic – GTBZ16AE	1	For GTBZ16AE
	9633019	Cosmetic – GTBZ18AE	1	For GTBZ18AE
3	9432021	Danger – Danger and Warning, Ground Control Station	1	
4	9132017	Label – The Ground Console Panel	1	
5	9431011	Warning – Explosion/fire hazard	3	
6	9421013	Warning – Do not step	4	
7	9311105	Notice – Main Power switch operation	1	
8	9231013	Label – Manufacturer’s Plate	1	
9	9331019	Notice – Battery charging instructions	1	
10	9331013	Instructions – Tie Down	4	
11	9331011	Instructions – Lifting	4	
12	9331015	Instructions – Double Arrow	2	
13	9432013	Warning – Crushing Warning	1	
14	9331017	Notice – emergency lower instructions	1	
15	9332015	Instructions – Highest Hydraulic Oil Level	1	
16	9332017	Instructions – Lowest Hydraulic Oil Level	1	
17	9334011	Notice – Operation Manual Storage	1	
18	9434085	Label – Safety Hook	4	
19	9134011	Label – Platform Console Panel 1	1	
20	9134015	Label – Platform Console Panel 2	1	
21	9134021	Label – Emergency Stop	1	
22	9134013	Label – Platform Console Panel 3	1	
23	9134017	Label – Platform Console Panel 4	1	
24	9134019	Label – Platform Console Panel 5	1	
25	9434057	Danger – Complex Warning	1	
26	9324011	Label – Open / Close	1	
27	9434081	Warning – Warning for Footswitch	1	
28	9434011	Label – Capacity 230kg	1	

Operation Instruction

Section 5

5.1 Description

This machine is a self-propelled hydraulic lift equipped with a work platform on the end of an elevating, articulating and rotating boom. Vibrations emitted by these machines are not hazardous to an operator in the work platform. The machine can be used to position personnel with their tools and supplies at position above ground level and can be used to reach work areas located above and over machinery or equipment.

A full and detailed implementation of EN ISO 13849-1/2 is correctly applied on our MEWP design. SISTEMA, a software tool for PL Calculation Tool, is also used to perform some relatively straightforward calculations on subsystem to determine the overall PL of the system. Reliability data, diagnostic coverage [DC], the system architecture [Category], common cause failure and, where relevant, requirements for software are used to assess the PL to comply with PLr of SRP/CS in Clause 5.11 of EN 280.

The primary operator control station is in the platform. From this control station, the operator can drive and steer the machine in both forward and reverse directions. The operator can raise or lower the boom or swing the boom to the left or right. Standard boom swing is 360 degree non-continuous left and right of the stowed position. The machine has a **Ground Control Station** which will override the Platform Control Station. Ground Controls operate boom lift and swing, and are to be used in an emergency to lower the platform to the ground should the operator in the platform be unable to do so. The Ground Control is also to be used in Pre-Start Inspection.

Instruction and hazard warnings are posted adjacent to both operator control stations and at other places on the machine. It is extremely important that operators know what instructions and warnings are placed on the machine, and review these periodically so that they are fresh in their minds.

There are efficient and safe operation in accordance with warnings on the machine, in the Operation & Maintenance Manual, and all jobsite and government rules and regulations. As with any type of machinery, the operator is very important to efficient and safe operation. It is absolutely necessary that the machine be regularly maintained in accordance with this manual and the machine Service and Maintenance manual, and that any evidence of lack of maintenance, malfunction, excessive wear, damage or modification to the machine be reported immediately to the machine owner or the jobsite supervisor or safety manager and that the machine be taken out of service until all discrepancies are corrected.

The machine is not intended to be used to lift material other than supplies which personnel in the platform require to do their job. Supplies or tools which extend outside the platform are prohibited. It must not be used as a forklift, crane, and support for overhead structure, or to push or pull another object.

The machine is equipped with an auxiliary hand pump which will provide hydraulic power in the event of a primary power loss. Auxiliary power can be used to lower the upper boom and the lower and mid boom instead of the primary power.

The machine is hydraulically powered using hydraulic motors and cylinders for various machine motions. The hydraulic components are controlled by electrically activated hydraulic valves using switches and control levers. The speeds of functions controlled by control levers are variable from zero to maximum speed depending upon the position of the control lever. Functions controlled by toggle switches are either on or off. A foot operated switch in the platform must be depressed before any controls will function and provides a means of emergency stop when the operator's foot is removed from the footswitch.

The machine Lift is a two wheel drive available machine with drive power being supplied by a electric motor for each drive wheel. Each drive wheel is supplied with an electrically released, spring-applied brake. These brakes are automatically applied any time the Drive Control lever is returned to the neutral position

The rated load of the machine is 230kg. This means that with a platform load of 230 kg or less, the platform may be positioned anywhere the boom will reach.

5.2 Operating Characteristics and Limitations

Capacities

The boom can be raised above horizontal with or without any load in platform, if:

- 1) Machine is positioned on a smooth, firm and level surface.
- 2) Load is within manufacturer's rated capacity.
- 3) All machine systems are functioning properly.
- 4) Proper tire pressure (for pneumatic tire).
- 5) Machine is as originally equipped from Dingli Co., Ltd.

Stability

Machine stability is based on two (2) conditions which are called FORWARD and BACKWARD stability. The machine's position of least FORWARD stability is shown in (See Figure5-1.), and its position of least BACKWARD stability is shown in (See Figure 5-2.)



TO AVOID FORWARD OR BACKWARD TIPPING, DO NOT OVERLOAD MACHINE OR OPERATE THE MACHINE ON AN OUT-OF-LEVEL SURFACE.

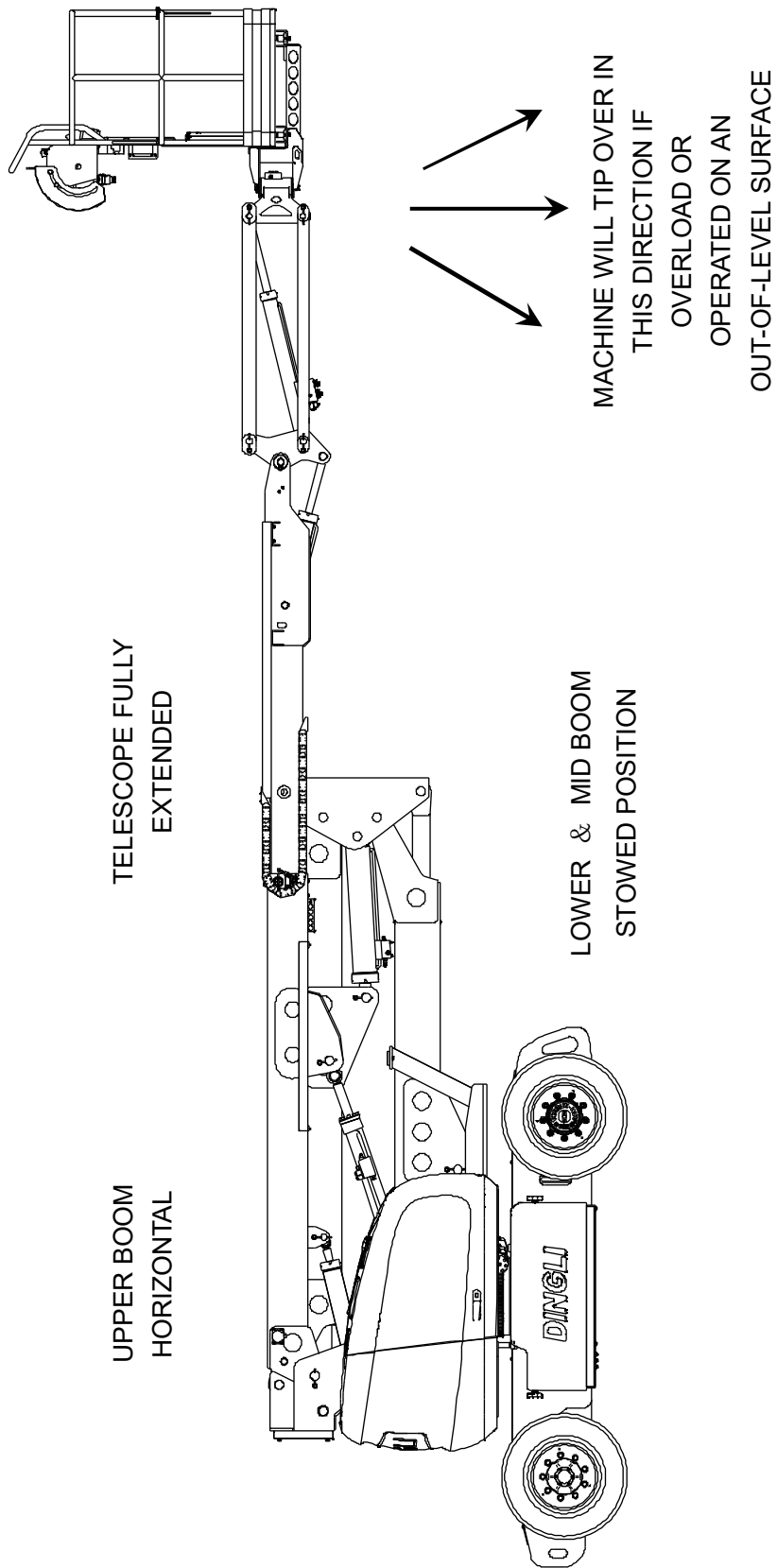

Figure 5-1 Position of Least Forward Stability

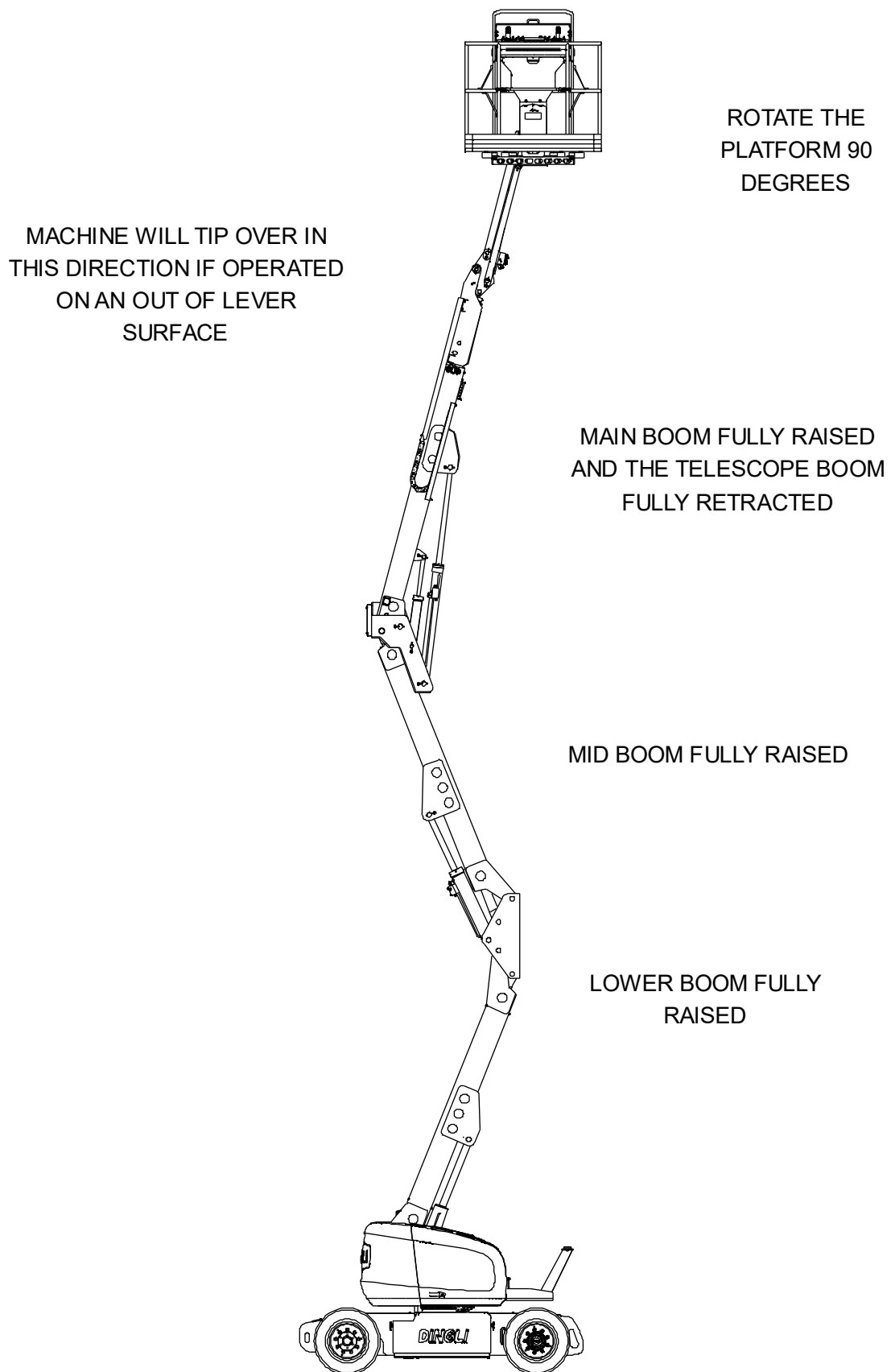

Figure 5-2 Position of Least Backward Stability

5.3 Traveling (Driving) Operation

⚠ WARNING

DO NOT DRIVE WITH BOOM EXTENDED OR ABOVE HORIZONTAL EXCEPT ON A SMOOTH, FIRM AND LEVEL SURFACE.

TO AVOID LOSS OF TRAVEL CONTROL OR “TIP OVER”, DO NOT DRIVE MACHINE ON GRADES EXCEEDING THOSE SPECIFIED ON THE SERIAL NUMBER TAG OR AS NOTED IN THE OPERATORS MANUAL.

DO NOT DRIVE ON SIDE SLOPES WHICH EXCEED 3 DEGREES.

USE EXTREME CAUTION WHEN DRIVING IN REVERSE AND AT ALL TIMES WHEN THE PLATFORM IS ELEVATED.

TRAVEL GRADES WITH DRIVE SPEED/TORQUE SELECT SWITCH IN THE FORWARD POSITION. USE CAUTION WHEN DRIVING IN REVERSE AND WHEN DRIVING WITH PLATFORM ELEVATED, ESPECIALLY WHEN DRIVING WITH ANY PART OF MACHINE WITHIN 6 FEET (2 M) OF AN OBSTRUCTION.

BEFORE DRIVING, MAKE SURE BOOM IS POSITIONED OVER REAR DRIVE AXLE. IF BOOM IS OVER FRONT WHEELS, STEER AND DRIVE CONTROLS WILL BE REVERSED.

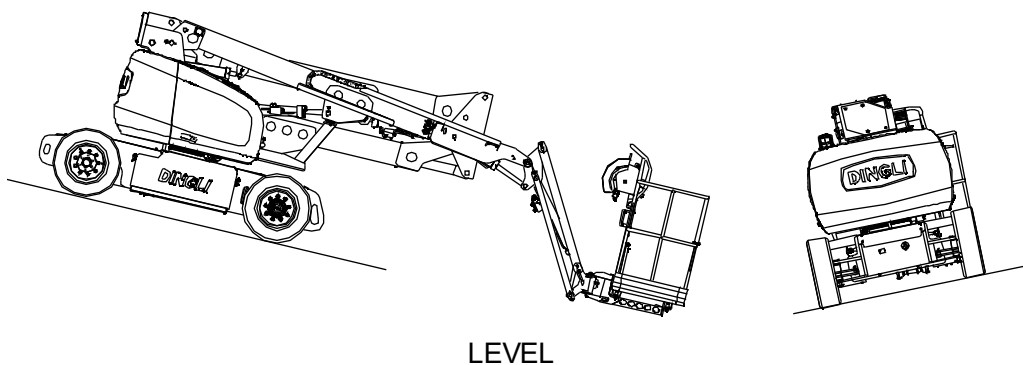

Do not drive the machine on grades and sideslopes exceeding those specified on the technical specification.

Traveling Forward and Reverse

- 1) With the emergency switch on, activate footswitch. Push down the button in the front surface of Drive/Steer Controller and hold on.
- 2) Position Drive controller to FORWARD or REVERSE as desired.

5.4 Steering Operation

- 1) With the emergency switch on, activate footswitch. Push down the button in the front surface of Drive/Steer Controller and hold on.

- 2) Position thumb switch on Drive/Steer controller to RIGHT for steering right, or to LEFT for steering left.

5.5 Platform Operation

Platform Level Adjustment



ONLY USE THE PLATFORM LEVELING OVERRIDE FUNCTION FOR SLIGHT LEVELING OF THE PLATFORM. INCORRECT USE COULD CAUSE THE LOAD/OCCUPANTS TO SHIFT OR FALL. FAILURE TO DO SO COULD RESULT IN DEATH OR SERIOUS INJURY.

This switch is used to adjust the platform level in situations such as ascending/descending a grade.

- 1) Activate footswitch (platform control station)
- 2) Leveling Up. Position the Platform Toggle Switch Level to Up and hold until platform is level.
- 3) Leveling Down. Position the Platform Level Toggle Switch Level to Down and hold until the platform is level.

Platform Rotation

- 1) Activated the Footswitch (platform control station)
- 2) To rotate the platform clockwise or anticlockwise, use the Platform Rotate control switch to select the direction and hold until desired position is reached.

5.6 Turntable Swinging Operation



DO NOT SWING OR RAISE BOOM ABOVE HORIZONTAL WHEN MACHINE IS OUT OF LEVEL.

DO NOT DEPEND ON TILT ALARM AS A LEVEL INDICATOR FOR THE CHASSIS.

TO AVOID SERIOUS INJURY, DO NOT OPERATE MACHINE IF ANY CONTROL LEVER OR TOGGLE SWITCH CONTROLLING PLATFORM MOVEMENT DOES NOT RETURN TO THE 'OFF' OR NEUTRAL POSITION WHEN RELEASED.

IF THE PLATFORM DOES NOT STOP WHEN A CONTROL SWITCH OR LEVER IS RELEASED, REMOVE FOOT FROM FOOTSWITCH OR USE EMERGENCY STOP SWITCH TO STOP THE MACHINE.

Swinging the turntable

Platform control station

- 1) Activated the Footswitch. Push down the button in the front surface of the main boom controller and hold on.
- 2) Move right to swing the turntable clockwise; move left to swing the turntable anticlockwise.

Ground control station

- 1) To swing boom clockwise or clockwise, use SWING control switch to select direction and hold until desired position is reached.

NOTICE

WHEN SWINGING THE BOOM MAKE SURE THERE IS AMPLE ROOM FOR THE BOOM TO CLEAR SURROUNDING WALLS, PARTITIONS AND EQUIPMENT.

5.7 Boom Operation

Raising and Lowering the Lower and Mid Boom

- 1) Activated the Footswitch (platform control station)
- 2) To raise or lower the Lower Boom, use Lower Boom Lift switch to select UP or DOWN movement.

WARNING

WHEN RAISE AND LOWER BOOM, CHECK FOR SMOOTH OPERATION. CHECK BOOM UPRIGHT TILTING FOR PROPER SYNCHRONIZATION. IF THE UPRIGHT IS TILTED OR THE BOOM WILL NOT FULLY LOWER, ADJUSTMENT SHOULD BE DONE ACCORDING TO THE BOOM SYNCHRONIZING PROCEDURE BELOW:

Boom Synchronizing Procedure

If the lower boom does not fully lower, use the following procedure.

- 1) Remove all personnel from the platform.
- 2) Pull out the red EMS (emergency stop) knob located on the ground control station.
- 3) Turn the platform/ground select switch to the ground control position.
- 4) Pull and hold out the red re-level knob on the synchronizing valve located beside the main control valve.

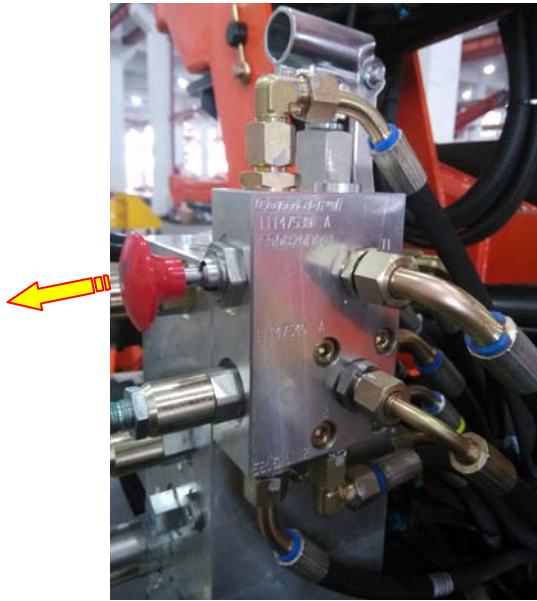

- 5) From the ground controls, activate the lift control switch, and raise the lower boom approximately 6 feet (2 m).
- 6) After raising the lower boom, release the red knob.

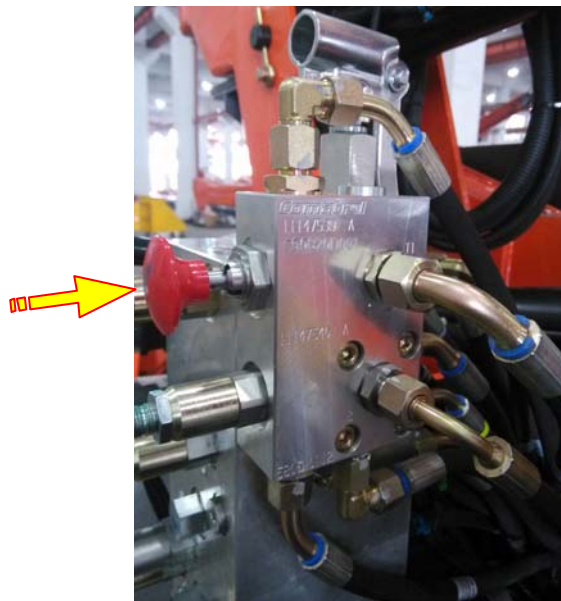

- 7) Activate the lift control switch and fully lower the boom and continue to hold down the switch for an additional 5 seconds.
- 8) Repeat steps 5 thru 7 if necessary.

Telescoping the Main Boom

- 1) Activated the Footswitch (platform control station)
- 2) To extend or retract the main boom, use the Main Telescope Control Switch to select IN or OUT movement.

Raising and Lowering the Main (Upper) Boom

- 1) Activated the Footswitch (platform control station)
- 2) To raise or lower the Upper Boom, use Upper Boom Lift switch to select UP or DOWN movement.

5.8 Auxiliary Pump Operation

NOTICE

WHEN OPERATING ON AUXILIARY PUMP, ONLY CAN LOWERING UPPER BOOM , LOWER AND MID BOOMS BE OPERATED.ALL OF OTHER FUNCTIONS CAN NOT BE OPERATED.

The main function of auxiliary pump is to lower the platform in the event of primary power failure. Determine the reason for primary power failure and have the problem corrected by a certified service technician. Operate as follows:

Manually Descent Booms:

- 1) Turn manual descent knob on main valve counterclockwise (clockwise) to LU (LR) identification code near the knob on the main valve.
- 2) Install handle into manual descent pump and lower the Mid and Lower Booms (Upper Boom) by pumping the handle until they are completely lowered.
- 3) Turn manual descent knob clockwise (counterclockwise) to LR (LU) identification code near the knob on the main valve and lower the Upper Boom (Mid and Lower Booms) by pumping the handle until it is completely lowered.
- 4) Stow handle in bracket provided.

5.9 Shut Down and Parking

- 1) Drive machine to a reasonably well protected area.
- 2) Be sure the main boom is fully retracted and lowered over rear drive axle.
- 3) Remove all load from the platform.
- 4) At Ground Controls, turn KEY SELECT switch to OFF position. Push in the Emergency Stop. Remove key.
- 5) If necessary, cover Platform Control console to protect instruction placards, warning decals and operating controls from hostile environment.

5.10 Lifting and Tie Down

Lifting Operation

- 1) Refer to the Serial Number Tag, to make sure the Gross Vehicle Weight.
- 2) Place the boom in the stowed position.

- 3) Remove all loose items from the machine.
- 4) Properly adjust the rigging to prevent damage to the machine and so the machine remains level.

If it becomes necessary to lift the machine using an overhead or mobile crane, it is very important that the lifting devices are attached only to the designated lifting eyes. (See Figure 5-3. Lifting Diagram)

NOTICE

LIFTING EYES ARE PROVIDED AT THE FRONT AND REAR IN THE FRAME SLAB. EACH OF THE FOUR CHAINS OR SLINGS USED FOR LIFTING MACHINE MUST BE ADJUSTED INDIVIDUALLY SO MACHINE REMAINS LEVEL WHEN ELEVATED.

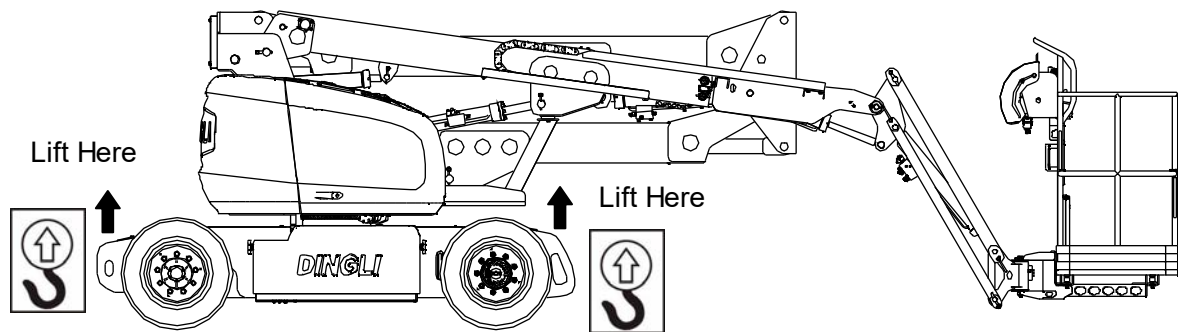

Figure 5-3 Lifting Diagram

Tie Down Operation

NOTICE

WHEN TRANSPORTING MACHINE, BOOM MUST BE IN THE STOWED MODE AND MACHINE SECURELY TIED DOWN TO TRUCK OR TRAILER DECK. FOUR TIE DOWN EYES ARE PROVIDED IN THE FRAME SLAB, ONE AT EACH CORNER OF THE MACHINE. (SEE FIGURE 5-3. AND FIGURE 5-4.)

- 1) Place the boom in the stowed position.
- 2) Remove all loose items from the machine.
- 3) Secure the chassis and the platform using straps or chains of adequate strength.

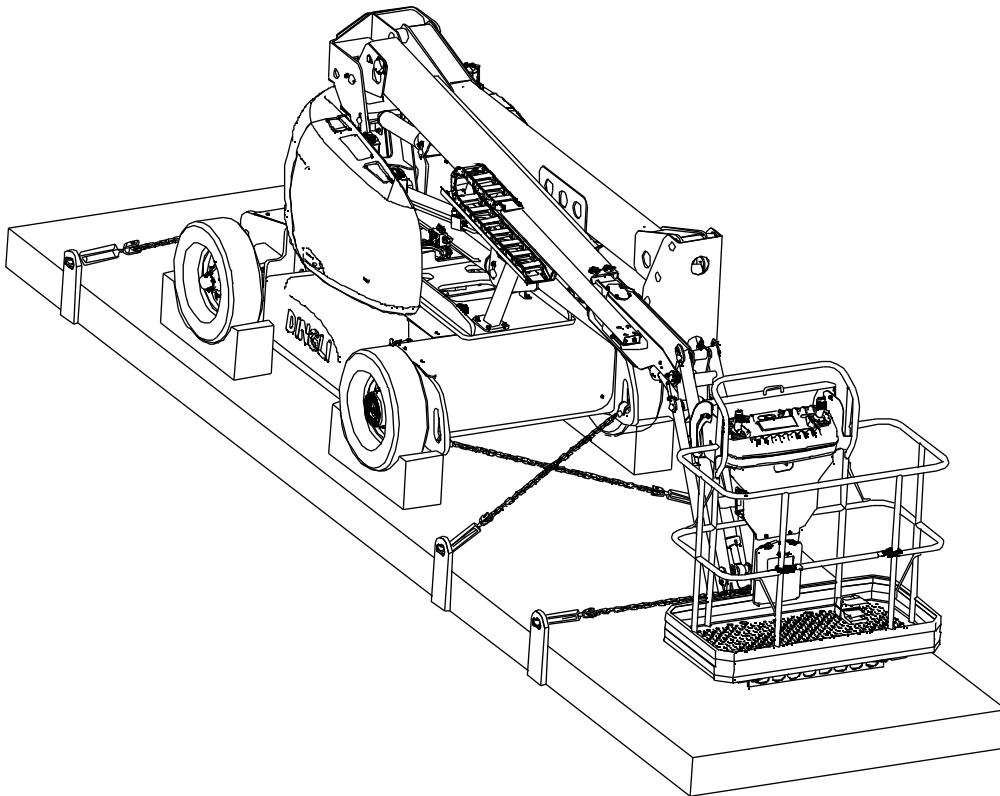

Figure 5-4 Tie Down Diagram

5.11 Towing Operation

⚠ WARNING

RUNAWAY VEHICLE/MACHINE HAZARD. MACHINE HAS NO TOWING BRAKES. TOWING VEHICLE MUST BE ABLE TO CONTROL MACHINE AT ALL TIMES. ON-HIGHWAY TOWING NOT PERMITTED. FAILURE TO FOLLOW INSTRUCTIONS COULD CAUSE SERIOUS INJURY OR DEATH.

MAXIMUM TOWING SPEED 5 M.P.H. (8 K.M.H.) FOR NO LONGER THAN 30-45 MINUTES.

MAXIMUM TOWING GRADE 25%.

Prior to Towing

Prior to towing the machine, complete the following:

⚠ CAUTION

DO NOT TOW MACHINE WITH DRIVE HUBS ENGAGED.

- 1) Retract, lower and position boom over rear drive wheels in line with direction of travel.

- 2) Disconnect drive hubs by inverting disconnect cap. (See Figure 5-5.) After towing the machine, complete the following:
- 3) Reconnect drive hubs by inverting disconnect cap. (See Figure 5-5.)

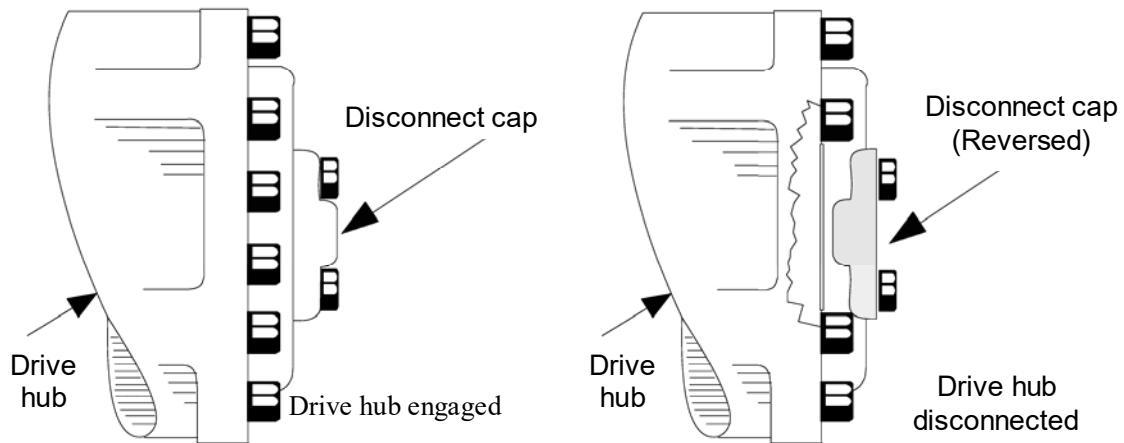

Figure 5-5 Disengage the Drive Hub

Emergency Procedures

Section 6

6.1 General

This section provides information on the procedures to be followed and on the systems and controls to be used in the event an emergency situation is encountered during machine operation. Prior to operation of the machine and periodically thereafter, the entire operating manual, including this section, should be reviewed by all personnel whose responsibilities include any work or contact with the machine.

6.2 Emergency Towing Procedures

Towing this machine is prohibited, unless properly equipped. However, provisions for moving the machine, in case of a malfunction or power failure, have been incorporated. The following procedures are to be used **ONLY** for emergency movement to a suitable maintenance area.

- 1) Chock wheels securely.
- 2) Disengage drive hubs by reversing disconnect caps.

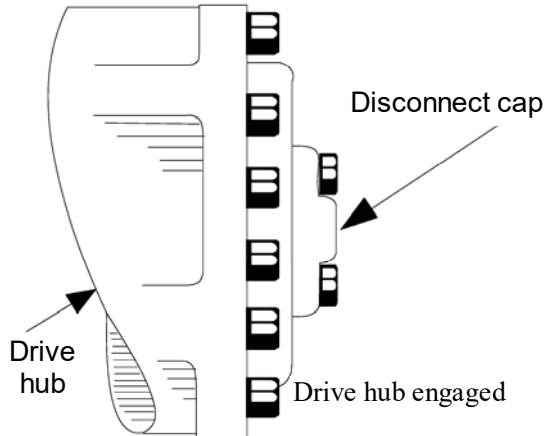

- 3) Connect suitable equipment, remove chocks, and move machine.

After moving machine, complete the following procedures:

- 1) Position machine on a firm and level surface.
- 2) Chock wheels securely.
- 3) Engage drive hubs by reversing disconnect caps on hubs.

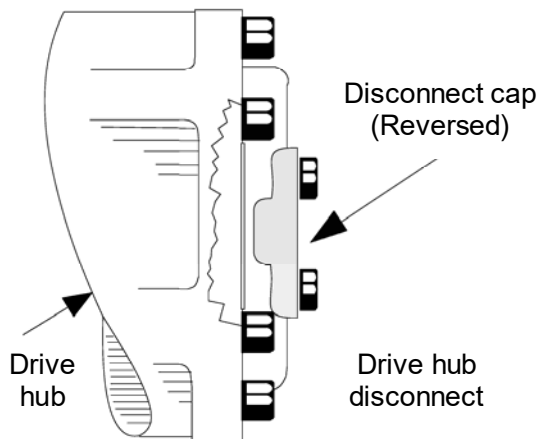

- 4) Remove chocks from wheels as needed.

6.3 Emergency Controls and Their Locations

6.3.1 Power/Emergency Stop Switches

- 1) There is one of these red mushroom shaped switches at both the *Ground Controls* and *Platform Controls*. When it is depressed it will immediately stop the machine.

⚠ WARNING

CHECK MACHINE DAILY TO MAKE SURE EMERGENCY STOP SWITCH GUARD IS IN PLACE AND THAT GROUND CONTROL INSTRUCTIONS ARE IN PLACE AND LEGIBLE.

- 2) Installed on the Platform Console, this round red switch is pulled up for normal machine functions. In an emergency, push the button to the down position with your palm and machine will immediately stop.

6.3.2 Ground Control Station

The Ground Control Station is located on the right front side of the turntable. The controls on this panel provide the means for overriding the platform controls, and for controlling the boom and swing functions from the ground. Place the KEY SELECT switch to GROUND position and operate the proper switch to lift, swing, or telescope the boom, or level the platform.

6.3.3 Auxiliary hand pump

The main function of auxiliary pump is to lower the platform in the event of primary power failure. Determine the reason for primary power failure and have the problem corrected by a certified service technician. The instruction is refer to Section 5.8.

NOTICE

WHEN OPERATING ON AUXILIARY PUMP, ONLY CAN LOWERING UPPER BOOM , LOWER AND MID BOOMS BE OPERATED.ALL OF OTHER

FUNCTIONS CAN NOT BE OPERATED.

6.4 Emergency Operation

6.4.1 Use of Ground Controls

Know how to use the ground controls in an emergency situation.

Ground personnel must be thoroughly familiar with the machine operating characteristics and the ground control functions. Training should include operation of the machine, review and understanding of this section and hands-on operation of the controls in simulated emergencies.

6.4.2 Operator Unable to Control Machine

If the Platform Operator Is Pined, Trapped or Unable to Operate or Control the Machine



DO NOT OPERATE WITH PRIMARY POWER SOURCE (ELECTRIC MOTOR) IF PERSONS ARE PINNED OR TRAPPED. USE AUXILIARY HAND PUMP INSTEAD.

- 1) Operate the machine from ground controls ONLY with the assistance of other personnel and equipment (cranes, overhead hoists, etc.) as may be required to safely remove the danger or emergency condition.
- 2) Other qualified personnel on the platform should not continue operation, and then the assistant on the ground descent the booms referring to section 5.8.
- 3) Cranes, forklift trucks or other equipment which may be available are to be used to remove platform occupants and stabilize motion of the machine in case machine controls are inadequate or malfunction when used.

6.4.3 Platform or Boom Caught Overhead

If the platform or boom becomes jammed or snagged in overhead structures or equipment, do not continue operation of the machine from either the platform or the ground until the operator and all personnel are safely moved to a secure location. Only then should an attempt be made to free the platform using any necessary equipment and personnel. Do not operate controls to cause one or more wheels to leave the ground.

6.4.4 Post Incident Inspection and Repair

Following any incident, thoroughly inspect the machine and test all functions first from the ground controls, then from the platform controls. Do not lift above 3 m (10 feet) until you are sure that all damage has been repaired, if required, and that all controls are operating correctly.

6.4.5 Manual Swing Override

The manual swing override is used to manually swing boom and turntable in the event of a total power failure when the platform is positioned over a structure or obstacle. To operate the manual swing override, proceed as follows:

1. Using a 7/8(22) inch(mm) socket and ratchet wrench, locate nut on swing worm gear on left side of machine.
2. Install wrench on nut ratchet in the direction desired.

6.5 Incident Notification

It is imperative that Dingli Machinery Co.,Ltd. be notified immediately of any incident involving a Dingli product. Even if no injury or property damage is evident, the factory should be contacted by telephone, fax or email and provided with all necessary details.

It should be noted that failure to notify the manufacturer of an incident involving a Dingli product within 48 hours of such an occurrence may void any warranty consideration on that particular machine.

In China Mainland:

Phone: +86 572 8681685 (8 Am till 4:30PM)

Fax: +86 572 8681687

Email: sales@ccdingli.com

Outside China Mainland:

Phone: +86 572 8681688

Fax: +86 572 8681690

Email: export@cndingli.com

General Maintenance

Section 7

7.1 General

This section of the manual provides additional necessary information to the operator for proper operation and maintenance of this machine. The maintenance portion of this section is intended as information to assist the machine operator to perform daily maintenance tasks only, and does not replace the more thorough Preventive Maintenance and Inspection Schedule.

7.2 Lubrication Specification

Table7-1 Lubrication Specifications

KEY	SPECIFICATIONS
MPG	Multipurpose Grease having a minimum dripping point of 350° F (177° C). Excellent water resistance and adhesive qualities, and being of extreme pressure type. (Timken OK 40 pounds minimum.)
EPGL	Extreme Pressure Gear Lube (oil) meeting API service classification GL-5 or MIL-Spec MIL-L-2105
HO	Hydraulic Oil. API service classification GL-3, e.g. Mobil fluid 424.
OGL	Open Gear Lubricant - Mobiltac 375 or equivalent.

NOTE: It is recommended as a good practice to replace all filters at the same time.

7.3 Lubrication Diagram

Refer to the configure for normally lubrication point and Item

NOTICE

LUBRICATION INTERVALS ARE BASED ON MACHINE OPERATION UNDER NORMAL CONDITIONS. FOR MACHINES USED IN MULTI-SHIFT OPERATIONS AND/OR EXPOSED TO HOSTILE ENVIRONMENTS OR CONDITIONS, LUBRICATION FREQUENCIES MUST BE INCREASED ACCORDINGLY.

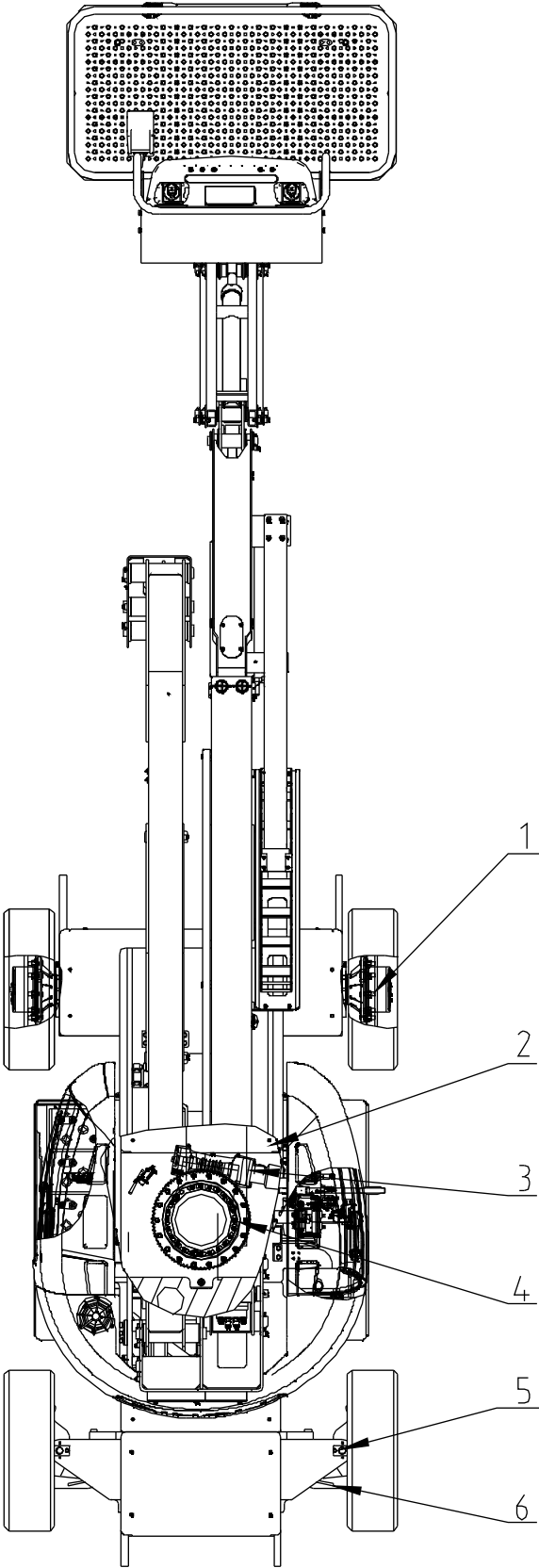

Figure 7-1 Operator Maintenance and Lubrication Diagram

7.4 Operator Maintenance

7.4.1 Wheel Bearings

A Wheel Bearings (2WD Only)

Lube Point(s) -	Repack
Capacity -	A/R
Lube -	MPG
Interval -	Every 2 years or 1200 hours of operation

B Wheel Drive Hub

Lube Point(s) -	Level/Fill Plug
Oil Capacity -	Per Hub about - 17 oz. - 1/2 Full
Lube -	EPGL, SAE 90 multipurpose hypoid gear oil- API service classification GL5, Mobile HD85W-90 is recommended.
Interval -	Check level every 3 months or 150 hrs of operation; change every 2 years or 1200 hours of operation.

Replacing the torque hub oil is essential for good machine performance and service life. Failure to replace the torque hub oil at yearly intervals may cause the machine to perform poorly and continued use may cause component damage.

- Elect the drive torque hub to be serviced. Then drive the machine until one of the two draining plugs is at the lowest point.
- Remove both plugs and drain the oil
- Drive the machine until one plug is at the top and the other is at 90 degree.
- Fill the hub with oil from the top hole until the oil level is even with the bottom of the side hole.
- Apply pipe thread sealant to the plugs, then to install the plugs.
- Repeat this procedure for each torque hub.

7.4.2 Lubrication for the Swing Bearing and Worm Gear

Yearly application to lubrication to the turntable bearing (Swing Bearing) and worm drive gear is essential to good machine performance and service life. Continued use of an improperly greased gear will result in component damage.

- 1) Raise the secondary boom and place a safety chock on the secondary boom lift cylinder. Carefully lower the boom onto the lift cylinder safety chock.



CRUSHING HAZARDS. KEEP HANDS AWAY FROM CYLINDER AND ALL MOVING PARTS WHEN LOWERING THE SECONDARY BOOM.

- 2) Located the grease fitting on the inside of the bearing in the middle of the turntable.
- 3) Pump grease into the turntable rotation bearing. Rotate the turntable in increments of 4 to 5 inch(10-13cm) at a time and repeat this step until the entire bearing has been greased.

CAUTION

DO NOT OVERGREASE END BEARINGS. OVERGREASING BEARINGS WILL RESULT IN BLOWING OUTER SEAL IN HOUSING.

- 4) Remove the safety chock. Lower the boom to the stowed position.
- 5) Locate the grease on the worm drive housing.
- 6) Pump grease into the gear until you see it coming out of the side of the gear housing.
- 7) Grease each tooth on the outside of the turntable rotation bearing.

Lubrication for Swing Bearing (Refer to the Figure 7-1 Item3)

Lube Point(s) -	4 Grease Fittings
Capacity -	A/R
Lube –	MPG
Interval -	Every 3 months or 150 hrs of operation

Lubrication for the Outer Gear Teeth (Refer to the Figure7-1 Item3)

Lube Point(s) -	The Outer Gear Teeth
Capacity -	A/R
Lube –	OGL
Interval -	Every one months or 50 hrs of operation

Lubrication for the Worm Gear (Refer to the Figure 7-1 Item 2)

Lube Point(s) -	2 Grease Fittings
Capacity -	A/R
Lube –	MPG
Interval -	Every year or 1000 hrs of operation

Comments - Remove grease fittings and install plugs after greasing

7.4.3 Test and Replace the Hydraulic Oil

Replacement and testing of the hydraulic oil is essential for good machine performance and service life. Dirty oil and suction strainers may cause the machine poorly and continued use may cause components damage. Extremely dirty conditions may require oil changes to be performed more often.

NOTICE

THE MACHINE USE DEXRON EQUIVALENT HYDRAULIC OIL, BEFORE REPLACING THE HYDRAULIC OIL DISTRIBUTOR FOR SPECIFIC LEVELS OF CONTAMINATION TO VERIFY THAT CHANGING THE OIL IS NECESSARY. IF THE HYDRAULIC OIL IS NOT REPLACED AT THE TWO YEAR INSPECTION, TEST THE OIL QUARTERLY. REPLACE THE OIL WHEN IT FAILS THE TEST.

Perform this procedure with the boom in the stowed position.

- 1) Remove the plug from the drain hose on the hydraulic reservoir
- 2) Completely drain the tank into a suitable container. See capacity specifications listed below.
- 3) Rinse out the inside of the tank with a mild solvent.
- 4) Change the Suction port filter net (refer Replace the Suction Filter)
- 5) Change the Return filter element (refer to Replace the Return filter element)
- 6) Change the Charge filter element (refer to Replace the Charge Filter Element)
- 7) Install the plug on the drain port.
- 8) Fill the tank with hydraulic oil use a 10um filter until the fluid is thin the top 2 inches of the sight gauge. Not overfill.
- 9) Disconnect the Port LR on the Main manifold, block it using a M16*1.5 Plug, and take a suitable container under the port of the hose,
- 10) Make sure the emergency switches on and put the toggle switch forward in the Ground Control Station to raise the main upper boom, take the hose and lead the oil from the cylinder rod chamber into the container.
- 11) Stop to reconnect the hose to the LR port.
- 12) Disconnect the Port LU on the Main manifold, block it using a M16*1.5 Plug, and take a suitable container under the port of the hose,
- 13) Put the toggle switch up in the Ground Control Station, to raise the Lower and Mid Boom, take the hose and let the oil from the cylinder rod chamber into the container.
- 14) Stop to reconnect the hose to the LU port.
- 15) Pull up the red re-level knob on the synchronizing valve located beside the main control valve manifold assembly.
- 16) Find the hose connected to the Port T1 on the synchronizing valve, and disconnect the end fitting which is located on the hydraulic reservoir, and block the port in the reservoir. Then take a suitable container under the hose to accept the oil.
- 17) Put the toggle switch lever forward in the Ground Control Station, to raise the Lower Boom, take the hose and let the oil from the cylinder non-rod chamber into the container.

- 18) Stop to reconnect the hoses to the T1 .
- 19) Disconnect the Port P2B on the Main manifold, block the port using a M16*1.5 Plug, and take a suitable container under the port of the hose.
- 20) Put the toggle switch forward in the Ground Control Station, to extend the main upper telescopic boom, take the hose to lead the oil from the cylinder rod chamber into the container.
- 21) Stop to reconnect the hose to the P2B port.

7.4.4 Replace the Hydraulic Filters

Replacement of the hydraulic filters is essential for good machine performance and service life. A dirty or clogged filter may cause the machine to perform poorly and continued using may cause component damage. Extremely dirty conditions may require that the filter be replaced more often.

Replace the Suction Filter Procedure:

- 1) Clean the area around the cover of the hydraulic oil reservoir.
- 2) Use a wrench to loose and remove the 12 bolts from the hydraulic oil reservoir cover, move the cover away from the reservoir, then turn the filter element from the adaptor.
- 3) Take a new filter element to screw it onto the filter adaptor.
- 4) Install the cover to hydraulic oil reservoir, and screw down 12 bolts.
- 5) The suction filter element Dingli Part Number is 5899-0912
- 6) Interval—Every 2years or 1200 hours of operation. Remove and clean at time of hydraulic oil change.

Replace the Return Filter Procedure:

- 1) Clean the area around the oil filter, then remove the filter assembly cover use a 5mm wrench.
- 2) Pull out the filter element from the filter assembly chamber.
- 3) Install the new filter element to the filter assembly chamber.
- 4) Install the filter assembly cover and tighten it. Clean up any oil that may have spilled during the replacement procedure.
- 5) The return filter assembly Dingli Part Number is 5899-0512.
- 6) Interval—Change after first 50 hrs, and every 6 months or 300 hrs. Thereafter or as indicated by Condition Indicator.



7.4.5 Tires & Wheels Maintenance

Tire Damage

For polyurethane foam filled tires, Dingli recommends that when any of the following are discovered, measures must be taken to remove the machine from service immediately and arrangements must be made for replacement of the tire or tire assembly.

- A smooth, even cut through the cord plies which exceeds 3 inches (7.5 cm) in total length.
- Any tears or rips (ragged edges) in the cord plies which exceeds 1 inch (2.5 cm) in any direction.
- Any punctures which exceed 1 inch in diameter.
- Any damage to the bead area cords of the tire

If a tire is damaged but is within the above noted criteria, the tire must be inspected on a daily basis to insure the damage has not propagated beyond the allowable criteria.

Tire Replacement

Dingli recommends a replacement tire be the same size, ply and brand as originally installed on the machine. Please refer to the Parts Manual for the part number of the approved tires for a particular machine model. If not using an approved replacement tire, we recommend that replacement tires have the following characteristics:

- Equal or greater ply/load rating and size of original
- Tire tread contact width equal or greater than original
- Wheel diameter, width, and offset dimensions equal to the original
- Approved for the application by the tire manufacturer (including inflation pressure and maximum tire load), unless specifically approved by the manufacture. Do not replace foam filled or ballast filled tire assembly with a pneumatic tire. When selecting and installing a

replacement tire, ensure that all tires are inflated to the pressure recommended. Due to size variations between tire brands, both tires on the same axle should be the same.

Wheel Replacement

The rims installed on each product model have been designed for stability requirements which consist of track width, tire pressure, and load capacity. Size changes such as rim width, center piece location, larger or smaller diameter, etc., without written factory recommendations, may result in an unsafe condition regarding stability.

Wheel Installation

It is extremely important to apply and maintain proper mounting torque.

⚠ WARNING

WHEEL NUTS MUST BE INSTALLED AND MAINTAINED AT TORQUE TO PREVENT LOOSE WHEELS, BROKEN STUDS, POSSIBLE DANGEROUS SEPARATION OF WHEEL FROM THE AXLE. TO USE ONLY THE NUTS MATCHED TO THE CONE ANGLE WHEEL.

Tighten the lug nuts to the proper torque to prevent coming loose. Use a torque wrench to tighten fasteners. If you do not have a torque wrench, tighten the fasteners with a lug wrench, then immediately have a service garage tighten the lug nuts to the proper torque. Over-tightening result in breaking the studs or permanently deforming mounting stud holes in the wheels. The proper procedure attaching wheels is as follows:

- 1) Start all nuts by hand to prevent cross threading. NOT use a lubricant on threads or nuts.
- 2) Tighten nuts in the following sequence:

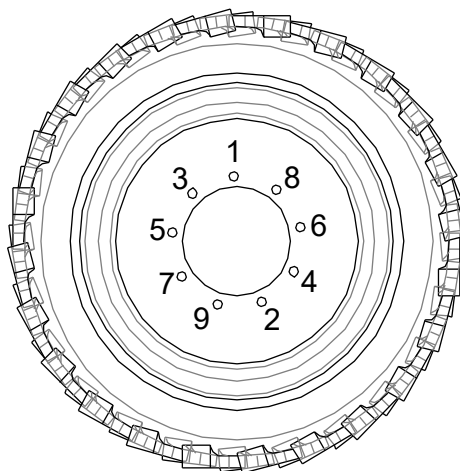

- 3) The tightening of the nuts should be done in stages. Following the recommended sequence tighten nuts per wheel torque chart.

TORQUE SEQUENCE		
1st Stage	2nd Stage	3rd Stage
40 ft. lbs. (55 N·m)	100 ft. lbs. (130 N·m)	170 ft. lbs. (255 N·m)

- 4) Wheel nuts should be torque after first 50 hours of operation and after each wheel removal. Check torque every 3 months or 150 hours of operation.

7.4.6 Battery Maintenance

WARNING

LEAD ACID BATTERIES PRODUCE FLAMMABLE AND EXPLOSIVE TO AVOID INJURY FROM AN EXPLOSION, DO NOT SMOKE OR ALLOW SPARKS OR A FLAME NEAR BATTERY DURING SERVICING. ALWAYS WEAR EYE PROTECTION WHEN SERVICING BATTERIES.

- 1) The battery is maintenance free except for occasional battery terminal cleaning, as noted in the following.
- 2) Remove battery cables from each battery post one at a time, negative first. Clean cables with acid neutralizing solution (e.g. baking soda and water or ammonia) and wire brush. Replace cables and/or cable clamp bolts as required.
- 3) Clean battery post with wire brush then re-connect cable to post. Coat non-contact surfaces with mineral grease or petroleum jelly (Vaseline).
- 4) When all cables and terminal posts have been cleaned, ensure all cables are properly positioned and are not pinched. Close battery compartment cover.

CAUTION

NEVER WORK ON THE ELECTRICAL SYSTEM OF ANY EQUIPMENT UNLESS YOU ARE THOROUGHLY FAMILIAR WITH SYSTEM DETAIL.

NEVER CHECK THE BATTERY BY PLACING A METAL OBJECT ACROSS THE POSTS. SERIOUS BURNS OR AN EXPLOSION CAN RESULT.

NEVER CHARGE A FROZEN BATTERY; IT CAN EXPLODE.

LEAD ACID BATTERIES CONTAIN SULFURIC ACID WHICH WILL DAMAGE EYES OR SKIN ON CONTACT. WHEN WORKING AROUND BATTERIES ALWAYS WEAR A FACE SHIELD TO AVOID ACID IN EYES. IF ACID CONTACTS EYES, FLUSH IMMEDIATELY EITHER CLEAR WATER AND GET MEDICAL ATTENTION. WEAR RUBBER GLOVES AND PROTECTIVE CLOTHING TO KEEP ACID OFF SKIN. IF ACID CONTACTS SKIN, WASH

OFF IMMEDIATELY WITH CLEAN WATER.

DISCONNECT THE BATTERY BEFORE WORKING ON THE ELECTRICAL SYSTEM. REMOVE THE GROUND TERMINAL FIRST. WHEN RECONNECTING THE BATTERY, RECONNECT THE GROUND TERMINAL LAST.

Schematics

Section 8

8.1 General

This section contains schematics to be used for locating and correcting most of the operating problems which may develop.

8.2 Troubleshooting

It should be noted that there is no substitute for a thorough knowledge of the equipment and related systems.

It should be recognized that the majority of the problems arising in the machine will be centered in the hydraulic and electrical systems.

The first rule for troubleshooting any circuit that is hydraulically operated and electrically controlled is to determine if the circuit is lacking hydraulic oil and electrical control power. This can be ascertained by overriding the bypass valve (mechanically or electrically) so that oil is available to the function valve, then overriding the function valve mechanically. If the function performs satisfactorily, the problem exists with the control circuit.

8.3 Hydraulic Circuit Checks

The best place to begin the problem analysis is at the power source (pump). Once it is determined that the pump is serviceable, then a systematic check of the circuit components, beginning with the control, would follow. For aid in troubleshooting, refer to the **followed hydraulic schematics and Electric schematics**.

8.3.1 Hydraulic Schematics

